

Travessa de reforço Reinforcing beam ** Poutre de renfort Travesaño de refuerzo	
Caixilho Pocket	Largura Width Largeur >= 900 mm
Caisson Armazón	Altura Height Hauteur >= 2200 mm

* Obriga a aplicação de 2 placas de gesso em cada face.
Requires the installation of 2 plasterboard sheets on each side.
Nécessite l'application de 2 plaques de plâtre sur chaque côté.
Se requiere la aplicación de 2 placas de cartón-yeso en cada lado.

⚠ Parafusos de fixação não incluídos.
Fixing screws not included.
Vis de fixation non incluses.
Tornillos de fijación no incluidos.

- (PT) **Atenção**
1m de altura depois de pavimento acabado
- (EN) **Warning**
Height of 1m after finished floor
- (FR) **Attention**
1m de hauteur après sol fini
- (ES) **Advertencia**
1 m de altura después del suelo acabado

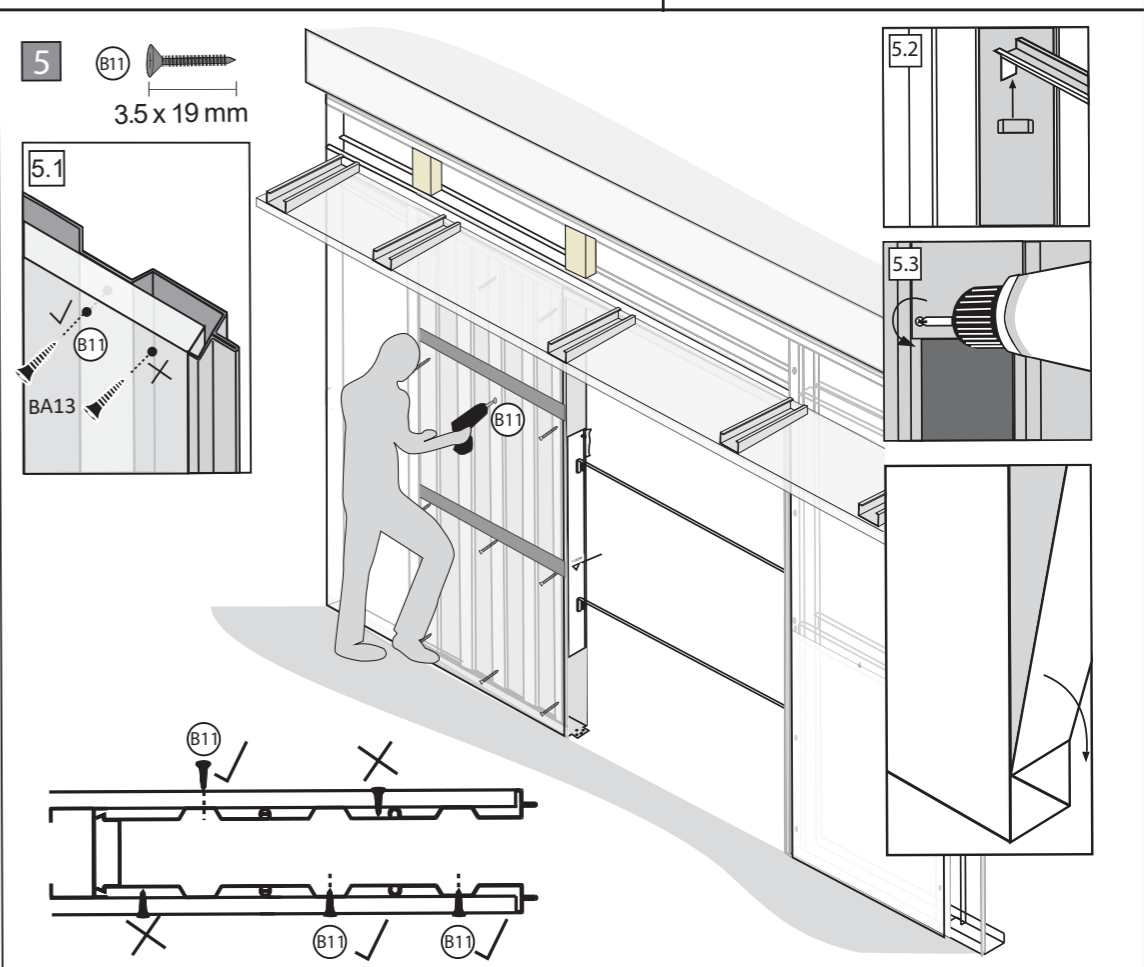
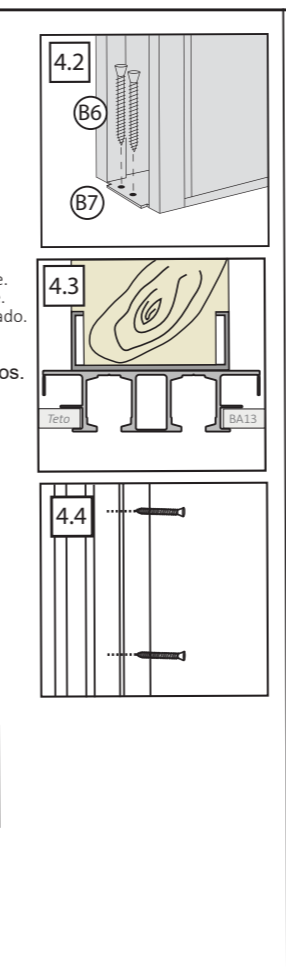

Aplicação da 1ª camada na horizontal
Installing the 1st layer horizontally
Appliquer la 1ère couche horizontalement
Aplicación de la primera capa horizontal

62X (B11)*

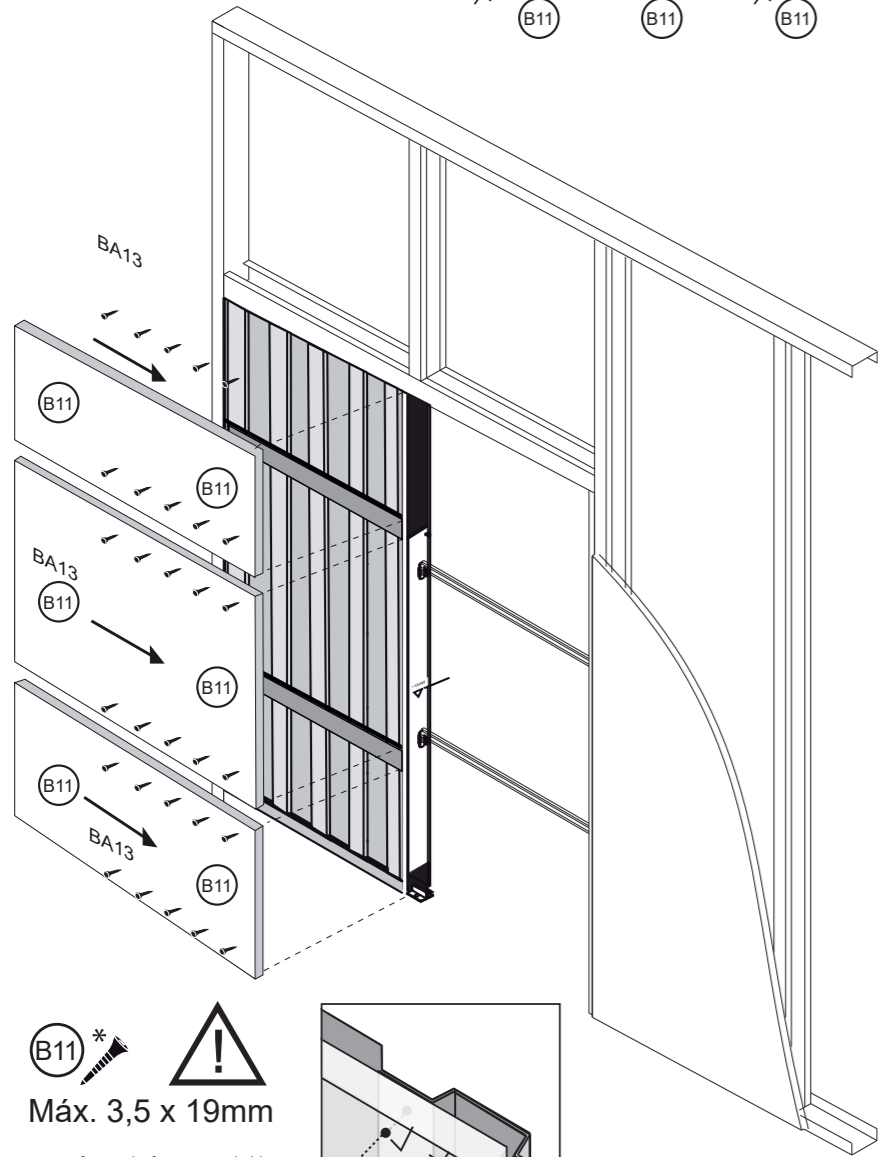
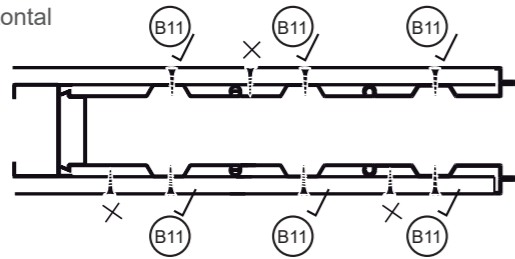

(B11)*
Máx. 3,5 x 19mm

Parafusos de fixação incluídos.
Fixing screws included.
Vis de fixation incluses.
Tornillos de fijación incluidos.

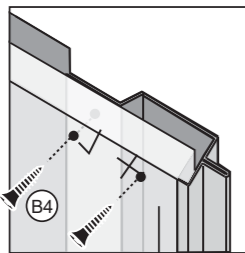

Aplicação da 2ª camada na Vertical
Installing of the 2nd layer vertically
Appliquer la 2ème couche dans le Vertical
Aplicación de la segunda capa en la vertical

52X (B12)*

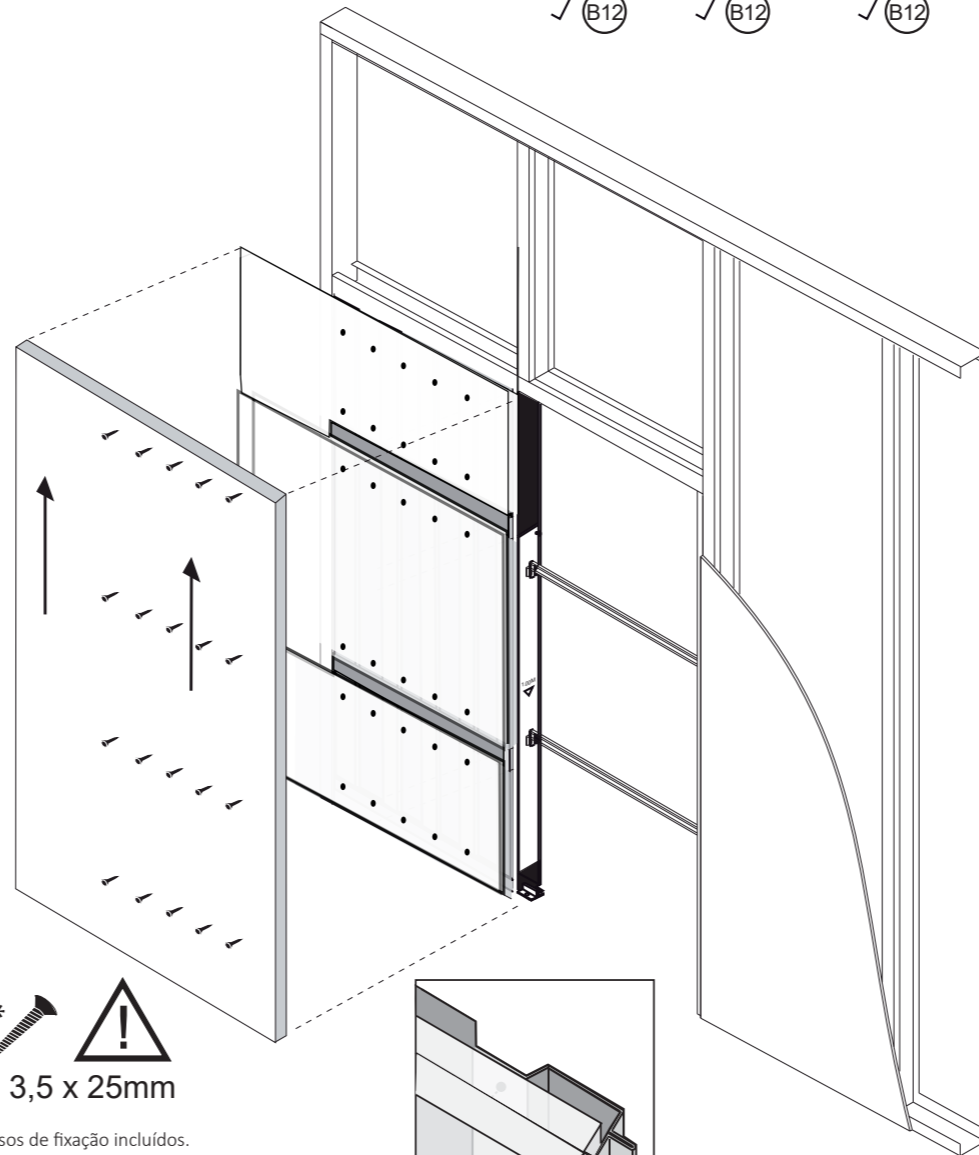
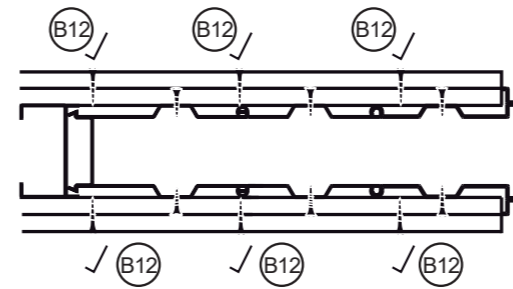

(B12)*
Máx. 3,5 x 25mm

Parafusos de fixação incluídos.
Fixing screws included.
Vis de fixation incluses.
Tornillos de fijación incluidos.

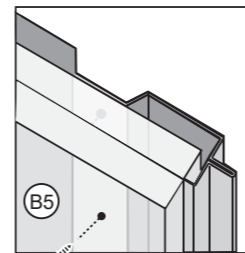

Finalização da aplicação
Finishing installation
Finir l'application
Finalización de la aplicación

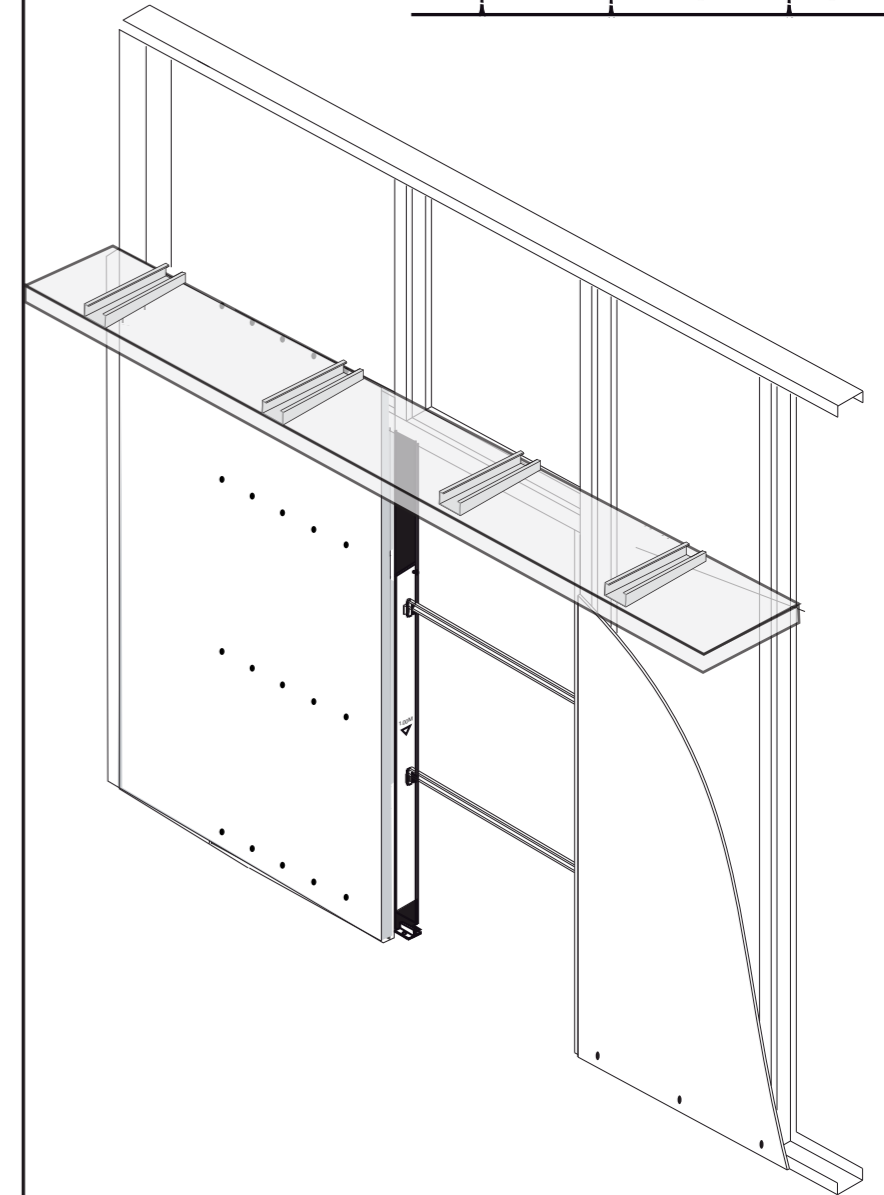
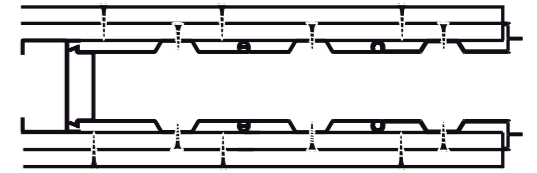

Atenção

Aplicável a todos os caixilhos com dimensões iguais ou superiores a 900mm de largura e 2200mm de altura. É obrigatório colocar 2 camadas de gesso cartonado sobre cada lateral do caixilho.

Advertencia

Applicable to all pocket frames with dimensions equal to or greater than 900mm width and 2200mm height. It is required to install 2 plasterboard sheets on each side of the frame.

Attention

Applicable à tous les contrechâssis des dimensions égales ou supérieures à 900mm de large et 2200mm de haut. Il est obligatoire de poser 2 plaques de plâtre de chaque côté du contrechâssis

Warning

Aplicable a todos los marcos con dimensiones iguales o superiores a 900 mm de ancho y 2200 mm de altura. Es obligatorio colocar 2 capas de cartón yeso sobre cada lateral del marco.

