



PAVIMENTOS E COMPLEMENTOS

Floorings and accessories  
Revêtements de sol et accessoires

**GS**floors®  
flooring solutions by gosmat

CATÁLOGO 2025  
Catalogue





## ÍNDICE

INDEX

<p><b>3 APRESENTAÇÃO</b> Presentation   Présentation</p> <p>3 Marca e Vantagens Brand and Advantages Marque et avantages</p> <p>4 Gamas Ranges Gammes</p>	<p><b>6 SPC   SOLID CLICK XL</b></p> <p>7 Vanilla Oak</p> <p>8 Pearl Oak</p> <p>9 Iron Oak</p> <p>10 Nature Oak</p> <p>11 Honey Oak</p> <p>12 Arizona Oak</p> <p>13 Smoked Oak</p> <p>14 Graphite Oak</p> <p>15 Arabian Oak</p> <p>16 Harvest Oak</p> <p>17 Castle Oak</p> <p>18 Ivory Oak</p> <p>19 Riga Amber</p> <p>20 Riga Terracota</p> <p>21 Coyote Oak</p> <p>22 Barley Oak</p> <p>23 Havana Oak</p> <p>24 Dakota Oak</p> <p>25 Signature Oak</p> <p>26 Ficha Técnica Technical sheet   Fiche technique</p>	<p><b>27 SPC   HERRINGBONE</b></p> <p>28 Arabian Oak</p> <p>29 Dakota Oak</p> <p>30 Ficha Técnica Technical sheet   Fiche technique</p> <p><b>31 SPC   ACOUSTIC</b></p> <p>32 Mystic Oak</p> <p>33 Forest Oak</p> <p>34 Bohemian Walnut</p> <p>35 Ficha Técnica Technical sheet   Fiche technique</p> <p><b>36 SPC   ESSENCE</b></p> <p>37 Mystic Oak</p> <p>38 Forest Oak</p> <p>39 Bohemian Walnut</p> <p>40 Royal Oak</p> <p>41 Heritage Oak</p> <p>42 Western Oak</p> <p>43 Urban Oak</p> <p>44 Ficha Técnica Technical sheet   Fiche technique</p>	<p><b>45 SPC   STONE</b></p> <p>46 Callacatta Praliné</p> <p>47 Stonecrete</p> <p>48 Noble Marble</p> <p>49 Ficha Técnica Technical sheet   Fiche technique</p> <p><b>50 COMPLEMENTOS</b> Complements   Compléments</p> <p>51 Perfis de escada Stair profiles Nez de marche</p> <p>53 Rodapés WPC e XPS WPC and XPS skirtings Plinthes en WPC et XPS</p> <p>54 Rodapés de alumínio Aluminium skirtings Plinthes en aluminium</p> <p>55 Perfis de remate Aluminium profiles Profils en aluminium</p> <p>60 Telas de isolamento Isolation underlays Sous couches</p> <p>61 Cores disponíveis Available colours Couleurs disponibles</p>
---	--	---	---

## APRESENTAÇÃO

PRESENTATION | PRÉSENTATION

A **GS FLOORS** é uma marca de pavimentos e complementos que apresenta soluções de qualidade distinta e disponibiliza uma vasta panóplia de artigos que aliam a resistência, o design e a funcionalidade. Toda a coleção que compõe a marca **GS FLOORS** foi meticulosamente produzida de acordo com as necessidades mais exigentes, dando forma aos projetos mais desafiantes em ambientes residenciais e comerciais. A gama **GS FLOORS** fica completa com os rodapés, perfis e telas de isolamento, de fácil aplicação e manutenção. Elementos imprescindíveis para conseguir a perfeita harmonia estética. O foco no cliente, o apoio técnico especializado e a forma como valorizamos os espaços interiores são os princípios que mais prezamos e que fazem da **GS FLOORS** uma marca de confiança!



(EN) **GS FLOORS** is a high-quality range of floorings and accessories that offers a wide variety of products combining resistance, design and functionality. The entire **GS FLOOR** collection was meticulously produced according to the most demanding needs, giving shape to the most challenging projects in residential and commercial environments. The **GS FLOORS** range is completed with skirting boards, profiles and underlays, which are of easy installation and maintenance, essential elements to achieve the perfect aesthetic harmony. The focus on the customer, the specialized technical support and the way we value housing spaces, are the principles we appreciate the most and that makes **GS FLOORS** a trusted brand!

(FR) **GS FLOORS** est une marque de revêtements de sol qui présente des solutions d'haute qualité et propose une large gamme des produits alliant résistance, design et fonctionnalité. L'ensemble de la collection qui compose la marque **GS FLOORS** a été méticuleusement fabriqué selon les besoins les plus exigeants, en donnant forme aux projets les plus ambitieux dans les environnements résidentiels et commerciaux. La gamme **GS FLOORS** est complète avec des plinthes, des profils et des sous-couches, faciles d'installer et à entretenir. Ceux sont des éléments essentiels pour atteindre une parfaite harmonie esthétique. L'accent mis sur le client, le support technique spécialisé et la façon dont nous valorisons les espaces intérieurs sont les principes que nous apprécions le plus et qui font de **GS FLOORS** une marque de confiance!

## VANTAGENS PAVIMENTO SPC SOLID CLICK

SOLID CLICK SPC FLOORINGS ADVANTAGES | AVANTAGES REVÊTEMENTS DE SOL SPC SOLID CLICK



**Sistema de click patenteado uniclíc nos 4 lados**  
Patented click system UNICLIC on all 4 sides  
Système breveté de UNICLIC sur les 4 côtés



**Inclui tela IXPE incorporada 1,5mm**  
Includes IXPE Underlay built-in 1,5mm  
1,5mm de IXPE Sous-couche incorporé



**Ultra resistência à humidade**  
Ultra moisture resistant  
Ultra résistant à l'humidité



**Complementos compatíveis com os padrões do pavimento (rodapés perfis de remate e escada).**  
Skirting boards and profiles compatible with flooring.  
Plinthes, profils et nez de marche compatibles avec le sol.



**Camada de proteção UV e anti manchas!**  
UV and anti-stain protection layer!  
Couche de protection UV et anti-taches!



**Acabamento extra mate**  
Extra matte finish  
Finition extra mat



**Núcleo com densidade superior a 2000 kg/m³**  
Core density greater than 2000 Kg / m³  
Densité du noyau supérieure à 2000 Kg / m³

## OPÇÕES TÉCNICAS | TECHNICAL OPTIONS | OPTIONS TECHNIQUES



**Micro Bisel**  
Micro Bevel  
Micro Biseau

SOLID CLICK XL  
ACOUSTIC  
HERRINGBONE  
ESSENCE  
STONE



**Bisel 4V**  
Bevel  
Biseau

SOLID CLICK XL  
ACOUSTIC



**EIR - Poro sincronizado**  
EIR - Embossed in Register  
EIR - Pore synchronisé

SOLID CLICK XL  
ACOUSTIC  
HERRINGBONE



**Poró "Real Wood"**  
"Real Wood" Texture  
Texture "Real Wood"

SOLID CLICK XL  
ESSENCE



## Gamas de pavimento SPC | SOLID CLICK

SPC Flooring ranges | SOLID CLICK  
Gamme de revêtements de sol SPC | SOLID CLICK

### O Conforto e o Design aos seus pés!

Design and confort at your feet!  
Le design et le confort à vos pieds!



### SPC | SOLID CLICK XL

Desenvolvida com base nas mais avançadas tecnologias, traduz o perfeito equilíbrio entre o conforto e o design, com todos os benefícios do vinil. Régua de grandes dimensões para um acabamento final mais impactante e dinâmico.

(EN) Developed based on the most advanced technologies and reflects the perfect balance between comfort and design, with all the benefits of vinyl. Large dimension plank for a more impactful and dynamic final finish.

(FR) Développée sur la base des technologies les plus avancées et traduit l'équilibre parfait entre confort et design, avec tous les avantages du vinyle. La planche est de grande dimension pour une finition finale plus impactante et dynamique.

### SPC | SOLID CLICK ESSENCE

A sofisticação da simplicidade e a robustez do SPC na solução adequada para unificar e revigorar toda uma decoração.

(EN) The sophistication of simplicity and the robustness of SPC in the right solution to unify and invigorate an entire decoration.

(FR) La sophistication de la simplicité et la robustesse du SPC dans la bonne solution pour unifier et dynamiser toute une décoration.

### SPC | SOLID CLICK STONE

A autenticidade dos visuais de pedra que se retratam numa notável dinâmica estética, onde paralelamente a excelência da tecnologia SPC, intensifica todas as suas especificidades.

(EN) The authentic stone visuals, which are portrayed in a remarkable aesthetic dynamic, where, in parallel, the excellence of SPC technology intensifies all its specificities.

(FR) Les visuels de pierre authentiques, représentés dans une dynamique esthétique remarquable, où, en parallèle, l'excellence de la technologie SPC intensifie toutes ses spécificités.

### SPC | SOLID CLICK ACOUSTIC

Graças à sua estrutura robusta e à camada acústica integrada, esta coleção garante um admirável desempenho acústico e uma excelente relação entre a funcionalidade e o design.

(EN) Thanks to its robust structure and integrated acoustic layer, this collection guarantees remarkable acoustic capacity and provides an excellent balance between functionality and design.

(FR) Grâce à sa structure robuste et à sa couche acoustique intégrée, cette collection garantit une capacité acoustique remarquable et offre un excellent équilibre entre fonctionnalité et design.

### SPC | SOLID CLICK HERRINGBONE

Tipologia de aplicação tradicionalmente designada "em espinha", proporciona um resultado final verdadeiramente marcante e harmonioso, repleto de personalidade.

(EN) Its application typology in herringbone style, provides a truly striking and harmonious final result, full of personality.

(FR) Sa typologie d'application en chevrons, offre un résultat vraiment saisissant et harmonieux, plein de personnalité.

**PAVIMENTO SPC | SOLID CLICK**

SPC FLOORING | SOLID CLICK

REVÊTEMENTS DE SOL SPC | SOLID CLICK

**INCLUI TELA IXPE INCORPORADA 1,5MM**

Includes IXPE Underlay built-in 1,5mm  
1,5mm de IXPE Sous-couche incorporé

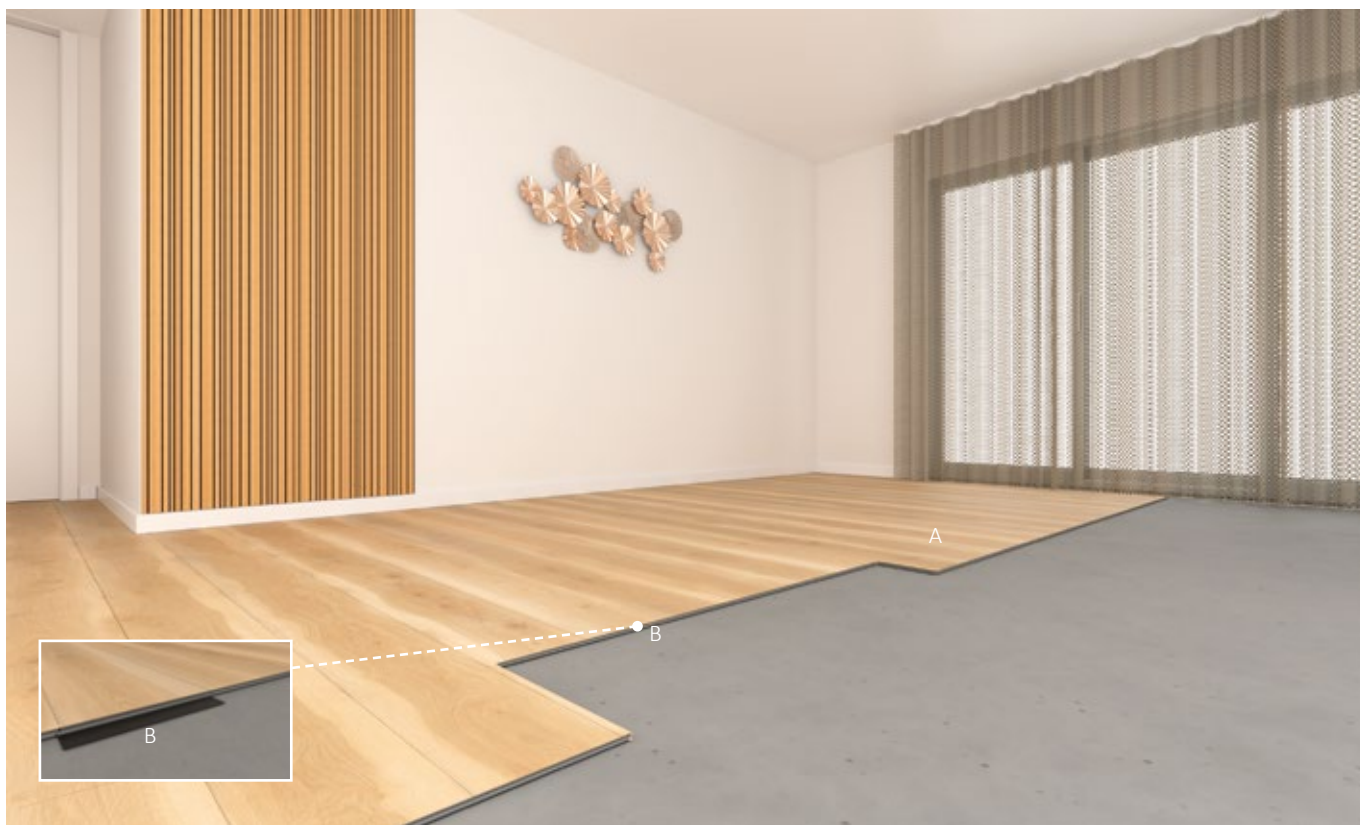

**APLICAÇÃO COMPATÍVEL COM PISO RADIANTE!**

Suitable for heated floor  
Compatible avec des planchers chauffants

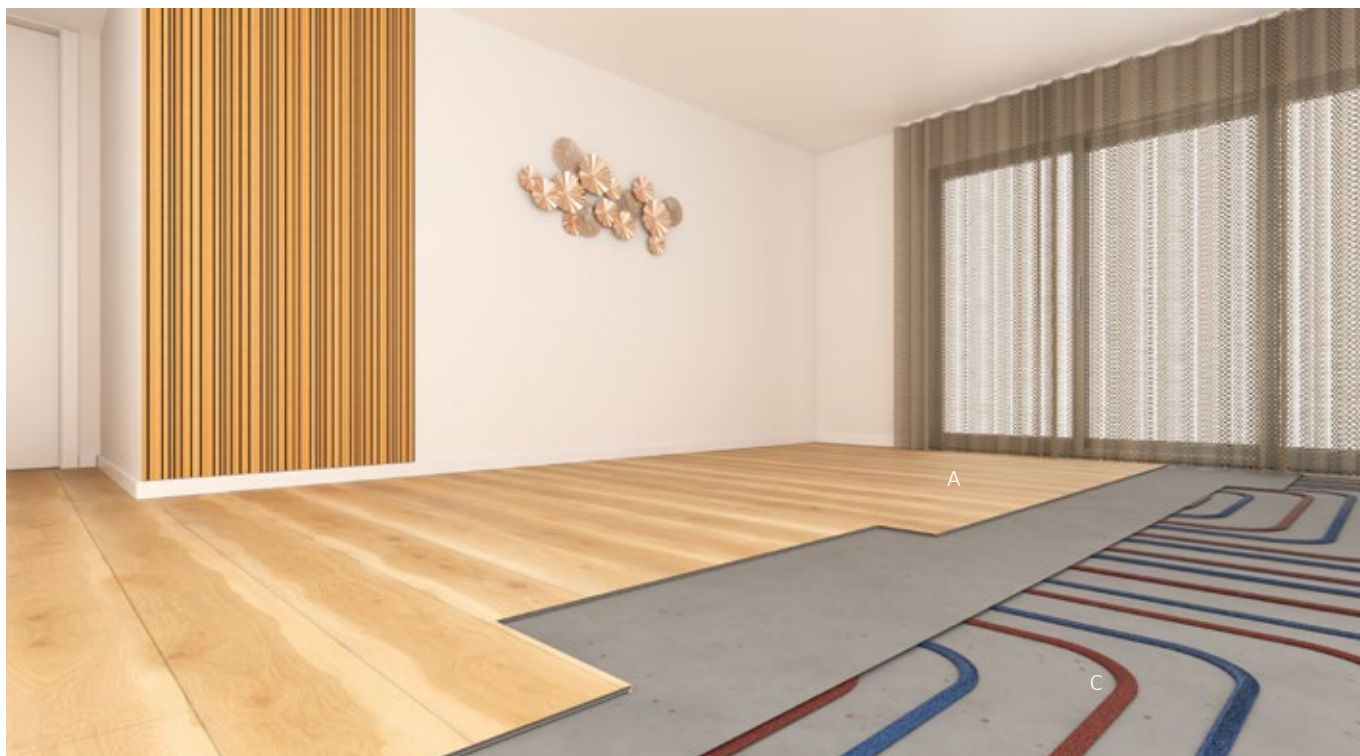

**A - Pavimento vinílico SPC | SOLID CLICK**

SPC Vinyl flooring | SOLID CLICK

Revêtement de sol en vinyle SPC | SOLID CLICK

**B - Tela de isolamento IXPE 1,5 mm incorporada**

1,5 mm IXPE built-in underlay

Sous-couche 1,5 mm IXPE intégré

**C - Piso radiante**

Heated floor

Planchers chauffants



# SPC | SOLID CLICK XL

CAMADA DE DESGASTE  
0,7  
mm  
Wear Layer | Couche d'usure

A gama de pavimento vinílico SOLID CLICK XL foi desenvolvida com base nas mais avançadas tecnologias e traduz o perfeito equilíbrio entre o conforto e o design, combinando visuais de luxo com todos os benefícios do vinil. Apresenta uma forte resistência à humidade, tratamento antibacteriano, uma estrutura multicamadas com núcleo rígido de grande estabilidade dimensional e um sistema de clique patenteado nos 4 topos. Permite um caminhar silencioso e confortável, elevando desta forma as potencialidades de um pavimento SPC. A régua é de grandes dimensões e já inclui tela de isolamento IXPE de 1,5 mm!

(EN)

The SOLID CLICK XL vinyl flooring line was developed based on the most advanced technologies and reflects the perfect balance between comfort and design, combining luxury looks with all the benefits of vinyl. It has a strong resistance to dampness, antibacterial treatment, a multilayer structure with a rigid core, a great dimensional stability and a patented 4 side click system.

It allows a quiet and comfortable walking, elevating the potential of an SPC flooring. The plank is of a large dimension and already includes a 1,5 mm IXPE attached underlay!

(FR)

La gamme de revêtements de sol en vinyle SOLID CLICK XL a été développée sur la base des technologies les plus avancées et traduit l'équilibre parfait entre confort et design, en alliant visuels de luxe avec tous les avantages du vinyle.

Il a une forte résistance à l'humidité, un traitement antibactérien, une structure multicouche avec un noyau rigide avec une grande stabilité dimensionnelle et un système de clic breveté sur les 4 coins. Il permet une marche silencieuse et confortable en élevant ainsi le potentiel du revêtements de sol SPC. La planche est de grande dimension et comprend déjà une sous couche IXPE de 1,5 mm!

Solid  CLICK XL



Doméstico intenso  
Intense domestic  
Domestique intense



Comercial intenso  
Intense commercial  
Commercial intense



Industrial geral  
General industrial  
Commercial intense



Solid  CLICK XL

# VANILLA OAK

De aparência clean e elegante, o padrão VANILLA OAK com o seu tom de bege imaculado, não é uma mera tendência mas sim uma preferência intemporal.

Os seus suaves “nós” conferem-lhe um aspeto extremamente sofisticado e gracioso, tornando-se irrepreensível em qualquer tipo de decoração.

(EN) With a clean and elegant appearance, the immaculate beige tone of VANILLA OAK is not a mere trend but a timeless preference. Its soft grains give an extremely sophisticated and graceful look making it impeccable in any type of decoration.

(FR) Avec un aspect épuré et élégant, le VANILLA OAK avec son ton beige immaculé, n'est pas une simple tendance mais une préférence intemporelle. Ses veines douces lui donnent un aspect extrêmement sophistiqué et gracieux, ce qui lui rend impeccable dans tout type de décoration.

Ref: 40.0518.001.008

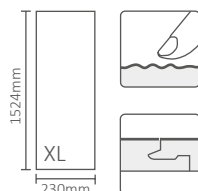

CAMADA DE DESGASTE  
0,7  
mm  
Wear Layer | Couche d'usure



Perfis | Profiles | Profils  
Vanilla Oak



Rodapés | Skirtings | Plinthes  
Vanilla Oak

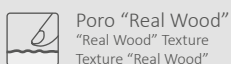

Poro “Real Wood”  
“Real Wood” Texture  
Texture “Real Wood”



Micro Bisel  
Micro Bevel  
Micro Biseau

Solid  CLICK XL

# PEARL OAK

O padrão PEARL OAK apresenta uma subtil diferença de tonalidades que o torna num visual único, capaz de elevar a dinâmica estética de qualquer espaço interior. Inspirado nas referências escandinavas e contemporâneas, garante uma conjugação perfeita com madeiras ou lacados.

(EN) The PEARL OAK presents a subtle difference in shades lending a unique look, capable of elevating the aesthetic dynamics of any interior space. Inspired by Scandinavian and contemporary references, it guarantees a perfect combination with wood or lacquered decors.

(FR) Le PEARL OAK présente une subtile différence de teintes que lui donne un look unique, capable d'élever la dynamique esthétique de tout espace intérieur. Inspiré des références scandinaves et contemporaines, il garantit une combinaison parfaite avec du bois ou laqué.

Ref: 40.0518.001.007

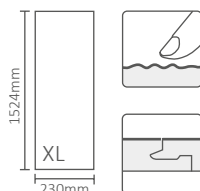
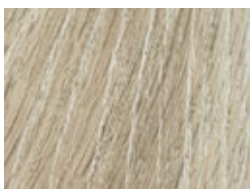
Perfis | Profiles | Profils  
Pearl OakRodapés | Skirtings | Plinthes  
Pearl OakPoro "Real Wood"  
"Real Wood" Texture  
Texture "Real Wood"Micro Bisel  
Micro Bevel  
Micro Biseau



Solid  CLICK XL

# IRON OAK

O pavimento IRON OAK segue a tendência dos cinzentos futuristas, ostentando alguns “veios” que lhe atribuem uma enorme versatilidade na sua aplicação. O resultado final é sublime quando conjugado com tons claros e uma decoração minimalista. Confere personalidade e conforto a qualquer envolvente.

(EN) The IRON OAK flooring follows the futuristic grey trend, displaying some grains that brings enormous versatility to its use in any design. The upshot is sublime when combined with light tones and minimalist décor, lending personality and comfort to any surrounding.

(FR) Le revêtement de sol IRON OAK suit la tendance du gris futuriste, avec quelques veines qui lui confèrent une énorme polyvalence dans son application. Le résultat final est sublime une fois combiné avec des tons clairs et un décor minimaliste. Il donne de la personnalité et du confort à tous les environnements.



Ref: 40.0518.001.005

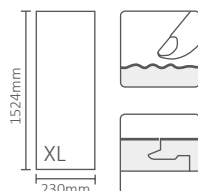

Perfis | Profiles | Profils  
Iron Oak



Rodapés | Skirtings | Plinthes  
Iron Oak



Poro “Real Wood”  
“Real Wood” Texture  
Texture “Real Wood”



Micro Bisel  
Micro Bevel  
Micro Biseau



# NATURE OAK

Evidencia-se dos demais pelo seu padrão com suaves “decapés”, o que lhe atribui um aspeto aprimorado e elegante. O seu tom de mel confundido no realismo do seu semblante permite que se adequue plenamente a decorações modernas e românticas. Oferece a qualquer espaço uma graciosidade e um carisma únicos!

(EN) It stands out from the rest of the collection for its pattern with smooth pickling wood tone that brings an enhanced and elegant look. Its honey tone allows it to fully adapt to modern and romantic decorations, lending to any space a unique elegance and charisma!

(FR) Il se démarque des autres par son motif aux décapés lisses, ce qui lui confère une apparence épuré et élégante. Son ton miel lui permet de s'adapter pleinement aux décors modernes et romantiques. Il offre à chaque espace une grâce et un charme uniques!

Ref: 40.0518.001.004

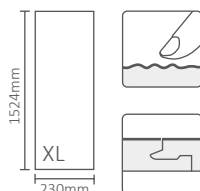
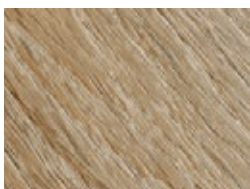

Perfis | Profiles | Profils  
Nature Oak



Rodapés | Skirtings | Plinthes  
Nature Oak



Poro "Real Wood"  
"Real Wood" Texture  
Texture "Real Wood"



Micro Bisel  
Micro Bevel  
Micro Biseau



Solid  CLICK XL

# HONEY OAK

A inspiração no carvalho natural faz do HONEY OAK um dos padrões mais apreciados da coleção. A versatilidade na sua aplicação é manifesta, exibindo todo o seu potencial nos estilos contemporâneo, retro e até mesmo vintage. O seu look intemporal aliado ao realismo das suas “catedrais” evoca a natureza e a vivacidade em ambientes assumidamente vanguardistas!

(EN) The inspiration in natural oak makes HONEY OAK one of the most appreciated colours of the entire collection. Its versatility is evident, showing its full potential on contemporary, retro and even on vintage styles. Its timeless look combined with the realism of its “cathedrals”, evokes nature and liveliness in avant-garde environments!

(FR) Inspiré par le chêne naturel, HONEY OAK est l'un des motifs les plus appréciés de toute la collection. La polyvalence de son application est évidente, en montrant son plein potentiel dans les styles contemporains, rétro et vintage. Son look intemporel combiné au réalisme de ses “grains”, évoque la nature et la vivacité dans des environnements avant-gardistes!

Ref: 40.0518.001.001

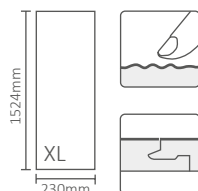

CAMADA DE DESGASTE  
0,7  
mm  
Wear Layer | Couche d'usure



Perfis | Profiles | Profils  
Honey Oak



Rodapés | Skirtings | Plinthes  
Honey Oak



Poro “Real Wood”  
“Real Wood” Texture  
Texture “Real Wood”



Micro Bisel  
Micro Bevel  
Micro Biseau



# ARIZONA OAK

O estilo country está bem patente no pavimento ARIZONA OAK! O seu visual faz mais sentido quando se torna cúmplice das tendências vintage, boémias e ancestrais.

De uma tonalidade ímpar, o ARIZONA OAK é facilmente aceite pelo cliente que procura a diferença e uma habitação mais atrativa e vibrante.

(EN) The country style is evident in the ARIZONA OAK! Its look makes more sense when blended with vintage, bohemian and ancestral trends.  
With a unique tone, ARIZONA OAK is easily selected by customers that are looking for the difference and a more attractive home.

(FR) Le style "country" est très évident dans le ARIZONA OAK! Son look prend tout son sens quand devient complice de tendances vintage, bohèmes et ancestrales.  
Avec un ton unique, le ARIZONA OAK est facilement accepté par des clients à la recherche d'une différence et d'une maison plus attrayante.

Ref: 40.0518.001.003

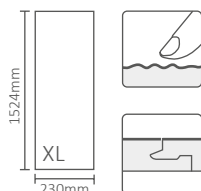
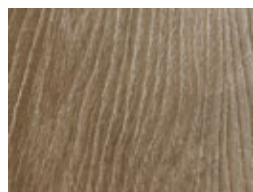

CAMADA DE DESGASTE  
0,7  
mm  
Wear Layer | Couche d'usure



Perfis | Profiles | Profils  
Arizona Oak



Rodapés | Skirtings | Plinthes  
Arizona Oak



Poro "Real Wood"  
"Real Wood" Texture  
Texture "Real Wood"



Micro Bisel  
Micro Bevel  
Micro Biseau



Solid  CLICK XL

# SMOKED OAK

A multiplicidade de tons fortes elevam o padrão SMOKED OAK para um limiar de absoluto carisma e vigor, tornando-se no elemento chave numa decoração minimalista.

O seu visual marcante adorna qualquer tipo de ambiente de extremo primor!

(EN) The multiplicity of tones of SMOKED OAK lends absolute charisma and vigor, becoming the key element in a minimalist decor. Its striking look upgrades any type of environment to extreme exquisite!

(FR) La multiplicité des tons forts élève le SMOKED OAK à un seuil de charisme et de vigueur absolu, en devenant l'élément clé d'un décor minimaliste. Son look saisissant orne tout type d'environnement d'extrême exquis!

Ref: 40.0518.001.002

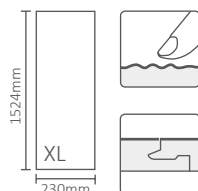

Perfis | Profiles | Profils  
Smoked Oak



Rodapés | Skirtings | Plinthes  
Smoked Oak



Poro "Real Wood"  
"Real Wood" Texture  
Texture "Real Wood"



Micro Bisel  
Micro Bevel  
Micro Biseau

Solid  CLICK XL

# GRAPHITE OAK

Robustez, intensidade e “hard look” são as palavras de ordem do GRAPHITE OAK. Permite conjugações criativas e vibrantes nos mais diversos estilos decorativos, desde moderno, industrial ou até mesmo rústico. Um autêntico desafio à sua imaginação!

(EN) Robustness, intensity and the “hard look” are the watchwords of GRAPHITE OAK. It allows creative and vibrant combinations on the most diverse decorative styles, from modern, industrial or even rustic. A real challenge to your imagination!

(FR) Robustesse, intensité et “hard look” sont les maîtres mots du GRAPHITE OAK. Il permet des combinaisons créatives et vibrantes dans les styles décoratifs les plus divers, du moderne, industriel ou même rustique. Un vrai défi pour votre imagination!

Ref: 40.0518.001.006

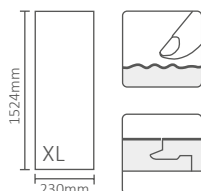
CAMADA DE DESGASTE  
0.7  
mm  
Wear Layer | Couche d'usurePerfis | Profiles | Profils  
Graphite OakRodapés | Skirtings | Plinthes  
Graphite OakPoro “Real Wood”  
“Real Wood” Texture  
Texture “Real Wood”Micro Bisel  
Micro Bevel  
Micro Biseau



Solid  CLICK XL

# ARABIAN OAK

O ARABIAN OAK apresenta toda uma mística e intensidade que se manifestam na sua dinâmica estética e particularmente no seu toque e na beleza contrastante dos seus veios e tonalidades. Facilmente remete para ambientes elegantes e plenos de dinamismo e originalidade em conciliação com os tipos de decoração moderna, oriental, étnica ou até mesmo vintage. Concede uma personalidade e carisma únicos em qualquer espaço!

(EN) The ARABIAN OAK presents a whole mystique and intensity manifested in its aesthetic dynamics and particularly on its touch and on the contrasting beauty of its veins and tones. It easily refers to elegant environments full of dynamism and originality in harmony with modern, oriental, ethnic or even vintage decor types, granting a unique personality and charisma to any space!

(FR) Le ARABIAN OAK présente toute une mystique et une intensité qui se manifestent dans sa dynamique esthétique et particulièrement dans son toucher et la beauté contrastée de ses veines et de ses tons. Il se réfère facilement à des ambiances élégantes pleines de dynamisme et d'originalité en conciliation avec les types de décors modernes, orientaux, ethniques ou encore vintage. Il accorde de la personnalité et du charme uniques à n'importe quel espace!

Ref: 40.0518.001.015

**Micro Bisel** | Micro Bevel | Micro Biseau

Ref: 40.0518.001.014

**Bisel 4V** | Bevel | Biseau

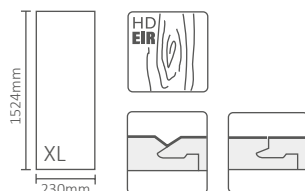

CAMADA DE DESGASTE  
0,7  
mm  
Wear Layer | Couche d'Usure  
HD EIR



Perfis | Profiles | Profils  
Arabian Oak



Rodapés | Skirtings | Plinthes  
Arabian Oak



EIR- Poro sincronizado  
EIR- Embossed in Register  
EIR- Pore synchronisé



Bisel 4V  
Bevel  
Biseau



Micro Bisel  
Micro Bevel  
Micro Biseau



Versão HERRINGBONE Pag: 28  
HERRINGBONE version Pag: 28  
Version à HERRINGBONE Pag: 28

Solid  CLICK XL

# HARVEST OAK

O destaque do pavimento HARVEST OAK é evidenciado pela sua forte inspiração na madeira natural, com um manifesto realismo e uma extraordinária autenticidade ao toque! O seu tom intemporal confere-lhe elevados índices de versatilidade e compatibilidade, tornando-se sempre numa aposta ganha. O HARVEST OAK é a certeza de uma excepcional sensação de conforto e personalidade em qualquer ambiente!

(EN) The accent of HARVEST OAK realistic is granted by its strong inspiration on natural wood, offering a realistic and an extraordinary authentic touch! The versatility and harmony of its timeless tone makes it always a winning bet. HARVEST OAK grants an exceptional feeling of comfort and personality to any environment!

(FR) Le point fort du parquet HARVEST OAK est mis en évidence par sa forte inspiration dans le bois naturel, d'un réalisme clair et d'une authenticité extraordinaire au toucher ! Son ton intemporel, lui donne des niveaux élevés de polyvalence et compatibilité, en le rendant toujours un pari gagnant. Le HARVEST OAK confère une sensation exceptionnelle de confort et de personnalité à tous les environnements!

Ref: 40.0518.001.016

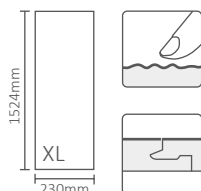
Perfis | Profiles | Profils  
Harvest OakRodapés | Skirtings | Plinthes  
Harvest OakPoros "Real Wood"  
"Real Wood" Texture  
Texture "Real Wood"Micro Bisel  
Micro Bevel  
Micro Biseau



# CASTLE OAK

O CASTLE OAK celebra a autenticidade do carvalho natural num padrão repleto de carisma. Confere a qualquer espaço um visual aprimorado e moderno, elevando e prestigiando todos os elementos decorativos à sua volta. As suas harmoniosas catedrais fundem-se perfeitamente no seu elegante tom de bege, proporcionando-lhe uma enorme versatilidade nos mais variados tipos de decoração, desde contemporânea, chic casual ou escandinava. Sem dúvida, uma escolha vencedora!

(EN) The CASTLE OAK celebrates the authenticity of natural oak in a pattern full of charisma. It gives any space an improved and modern look, elevating all the surrounding decorative elements. Its harmonious "cathedrals" blend perfectly into its elegant beige tone, providing a enormous versatility in the most varied types of decoration, from contemporary, casual chic or scandinavian. Definitely, a winning choice!

(FR) Le CASTLE OAK célèbre l'authenticité du chêne naturel dans un motif plein de charme. Il donne à n'importe quel espace un visuel moderne et amélioré, en élevant tous les éléments décoratifs qui l'entourent. Ses "cathédrales" harmonieuses se fondent parfaitement dans son élégant ton beige ou lui conférant une énorme polyvalence dans les différents types de décoration, du contemporain au casual chic en passant par le scandinave. Sans aucun doute, un choix gagnant!

Ref: 40.0518.001.012

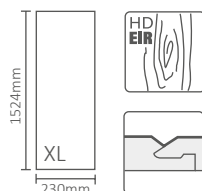

Solid  CLICK XL

# IVORY OAK

Com um estilo vanguardista e um toque sofisticado, o novo padrão IVORY OAK segue as tendências atuais e a sua adaptabilidade a qualquer projeto decorativo é simplesmente admirável. O tom intemporal de cinza claro aliado aos seus distintos veios e catedrais tornam-no num pavimento único e muito apreciado, originando um resultado final verdadeiramente vibrante e acolhedor.

(EN) With an avant-garde style and a sophisticated touch, the new IVORY OAK follows the current trends and its adaptability to any decorative project is simply admirable. The timeless tone of light grey combined with its distinct grains and "cathedrals" turns it into a unique and much appreciated flooring, resulting in a truly vibrant and welcoming outcome.

(FR) Avec un style avant-gardiste et une touche sophistiquée, le nouveau motif IVORY OAK suit les tendances actuelles et son adaptabilité à tout projet décoratif est tout simplement admirable. Le ton intemporel du gris clair combiné avec à ses veines et "cathédrales" distinctes lui convert dans un sol unique et très apprécié, en aboutissant à un résultat final vraiment vibrant et accueillant.

Ref: 40.0518.001.013

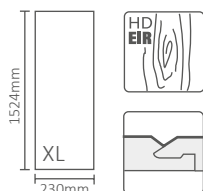
Perfis | Profiles | Profils  
Ivory OakRodapés | Skirtings | Plinthes  
Ivory OakEIR - Poro sincronizado  
EIR - Embossed in Register  
EIR - Pore synchroniséBisel 4V  
Bevel  
Biseau



Solid  CLICK XL

# RIGA AMBER

A nobreza da riga é expressamente evidente no décor aprimorado da nova Riga Amber! O seu toque e aparência dão um efeito de madeira muito natural, oferecendo uma riqueza e qualidade decorativa incontestáveis. Uma solução de excelência e versatilidade que se funde em pleno nos estilos decorativos clássicos ou vanguardistas, particularmente com inspirações Boho, orientais e provençais!

(EN) Riga's nobility is expressly evident on the enhanced decor of the new Riga Amber! Its touch and appearance delivers a very natural wood effect, offering an undeniable richness and decorative quality. A solution of excellence and versatility that fully merges with classic or avant-garde decorative styles, particularly with Boho, Oriental or Provence inspirations!

(FR) La noblesse de Riga s'exprime dans le décor amélioré du nouveau Riga Amber ! Son toucher et son aspect lui confèrent un effet bois très naturel, offrant en une richesse et une qualité décorative indéniables. Une solution d'excellence et de versatilité qui se fond parfaitement avec les styles décoratifs classiques ou avant-gardistes, notamment avec les inspirations bohèmes, orientales et provençales!

Ref: 40.0518.001.010

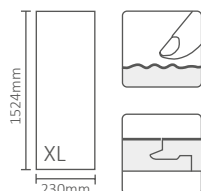

CAMADA DE DESGASTE  
0,7  
mm  
Wear Layer | Couche d'Usure



Perfis | Profiles | Profils  
Riga Amber



Rodapés | Skirtings | Plinthes  
Riga Amber

Solid  CLICK XL

# RIGA TERRACOTA

A Riga Terracota manifesta todo um visual exótico e carismático e torna-se no elemento mais excêntrico em qualquer ambiente decorativo! Combina plenamente com o branco imaculado, incorporado nos estilos minimalista, clean e escandinavo! O seu design apresenta variações de profundidade onde os distintos veios e “catedrais” acentuam os detalhes genuínos da riga. Concede charme e exuberância a qualquer espaço!

(EN) The RIGA TERRACOTA shows an exotic and charismatic look and becomes the most eccentric element on any home decor! It perfectly matches with the immaculate white, incorporated in minimalistic, clean and Scandinavian styles! Its design presents depth variations where the distinct grains and “cathedrals” accentuate the Riga’s genuine details. It grants charm and exuberance to any space!

(FR) Le RIGA TERRACOTA affiche un look exotique et charismatique et devient l’élément le plus excentrique de tout environnement décoratif ! Il s’accorde parfaitement avec le blanc immaculé, incorporé dans des styles minimalistes, épurés et scandinaves ! Sa conception présente des variations de profondeur où les distinctes veines et “cathédrales” accentuent les détails authentiques de Riga, en accordant du charme et de l’exubérance à n’importe quel espace!

Ref: 40.0518.001.011

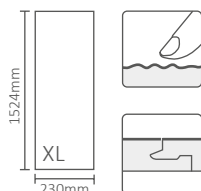
Perfis | Profiles | Profils  
Riga TerracotaRodapés | Skirtings | Plinthes  
Riga TerracotaPoro “Real Wood”  
“Real Wood” Texture  
Texture “Real Wood”Micro Bisel  
Micro Bevel  
Micro Biseau



Solid  CLICK XL

# COYOTE OAK

O novo Coyote Oak com o seu conceito rústico e vigoroso traz uma sensação de proximidade à natureza com as suas texturas naturais e tons quentes. A sua aplicação cria um ambiente convidativo e autêntico, e é perfeito para quem ambiciona um estilo intemporal e enigmático, onde a originalidade se difunde com a admirável elegância da madeira.

A verdadeira percepção de aconchego, onde o design se encontra com a funcionalidade!

(EN) The new Coyote Oak with its rustic and vigorous concept brings a closeness feeling to the nature with its natural textures and warm tones. It creates an inviting and authentic environment, and is perfect for those who seek a timeless and enigmatic style, where originality is spread with the admirable elegance of wood. The true perception of comfort, where design meets functionality!

(FR) Le nouveau Coyote Oak avec son concept rustique et vigoureux apporte une sensation de proximité avec la nature avec ses textures naturelles et ses tons chaleureux. Son application crée un environnement invitant et authentique, et est parfaite pour ceux qui recherchent un style intemporal et énigmatique, où l'originalité se mêle à l'admirable élégance du bois. La véritable perception du confort, où le design rencontre la fonctionnalité!

Ref: 40.0518.001.017

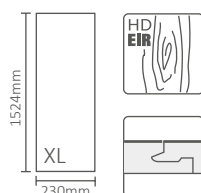

CAMADA DE DESGASTE  
0,7  
mm  
Wear Layer | Couche d'usure  
HD EIR



Perfis | Profiles | Profils  
Coyote Oak



Rodapés | Skirtings | Plinthes  
Coyote Oak



EIR- Poro sincronizado  
EIR- Embossed in Register  
EIR- Pore synchronisé



Micro Beisel  
Micro Bevel  
Micro Biseau

Solid  CLICK XL

# BARLEY OAK

Com um acabamento absolutamente luminoso e distinto, o novo padrão Barley Oak origina uma expressa sensação de amplitude e vitalidade que intensifica todo o potencial de um ambiente decorativo. O seu visual leve e suave reflete a luz de forma natural e a sua essência escandinava proporciona estilos verdadeiramente modernos e vibrantes. Onde a beleza da natureza se conecta com a geometria do design, criando uma comemoração de harmonia e distinção a cada detalhe.

(EN) With an absolutely distinctive and luminous finish, the new Barley Oak flooring creates an express sensation of spaciousness and vitality that intensifies the full potential of a decorative environment. Its light and soft look reflects light in a natural way and its Scandinavian essence provides truly modern and vibrant styles. Where the beauty of nature connects with the geometry of design, creating an harmony celebration on every detail.

(FR) Avec une finition absolument distinctive et lumineuse, le nouveau parquet Barley Oak crée une sensation expressive d'espace et de vitalité qui intensifie tout le potentiel d'un environnement décoratif. Son aspect léger et doux reflète la lumière de manière naturelle et son essence scandinave offre des styles vraiment modernes et dynamiques. Où la beauté de la nature se connecte à la géométrie du design, en créant une célébration de l'harmonie dans chaque détail.

Ref: 40.0518.001.020

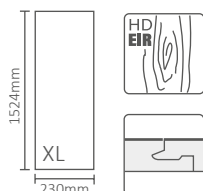
CAMADA DE DESGASTE  
0,7  
mm  
Wear Layer | Couche d'Usure  
HD EIRPerfis | Profiles | Profils  
Barley OakRodapés | Skirtings | Plinthes  
Barley OakEIR - Poro sincronizado  
EIR - Embossed in Register  
EIR - Pore synchroniséMicro Bisel  
Micro Bevel  
Micro Biseau



Solid  CLICK XL

# HAVANA OAK

O novo Havana Oak traz a pureza e a frescura da madeira para o seu espaço. Com tons suaves e veios delicados, recria ambientes distintos e harmoniosos, onde o realismo se faz presente em cada particularidade. Eleva toda uma decoração interior para uma envolvente leve e acolhedora, e ao mesmo tempo pleno de personalidade e carisma, enquadrando-se perfeitamente em todo o tipo de estilo decorativo. As suas tonalidades douradas expressam uma imensa sofisticação e uma escolha segura e inspiradora.

(EN) The new Havana Oak brings the purity and freshness of wood to your space. With soft tones and delicate veins, it recreates distinct and harmonious environments, where realism is present in each particularity. It elevates the entire decoration to a light and welcoming environment, and at the same time is full of personality and charisma, fitting perfectly into any type of decorative style. Its golden tones express immense sophistication and a safe and inspiring choice.

(FR) Le nouveau Havana Oak apporte la pureté et la fraîcheur du bois à votre espace. Avec des tons doux et des veines délicates, il recrée des environnements distincts et harmonieux, où le réalisme est présent dans chaque particularité. Il élève toute la décoration intérieure dans un environnement léger et accueillant, et en même temps plein de personnalité et de charisme, en s'intégrant parfaitement dans tout type de style décoratif. Ses tons dorés expriment une immense sophistication et un choix sûr et inspirant.

Ref: 40.0518.001.019

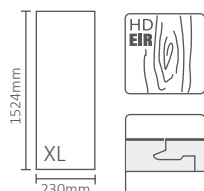

Perfis | Profiles | Profils  
Havana Oak



Rodapés | Skirtings | Plinthes  
Havana Oak



EIR- Poro sincronizado  
EIR- Embossed in Register  
EIR- Pore synchronisé



Micro Bisel  
Micro Bevel  
Micro Biseau

Solid  CLICK XL

## DAKOTA OAK

As tonalidades intensas e os veios marcantes do novo padrão Dakota Oak conferem uma personalidade ímpar a cada espaço, tornando-o imponente e acolhedor.

Apresenta um acabamento robusto e cores profundas que traduzem um charme muito particular, criando ambientes intimistas e repletos de carácter. Ideal para quem aprecia a beleza do natural aliada à força da expressividade, o Dakota Oak é a eleição que resiste ao tempo e amadurece com graciosidade.

(EN) The intense tones and the striking veins of the new Dakota Oak flooring give a unique personality to each kind of decoration, making it imposing and welcoming. It features a robust finish and deep colors that convey a very particular charm, creating intimate environments full of character. Ideal for those who appreciate natural beauty combined with the strength of expressiveness, the Dakota Oak is the choice that endures the test of time and matures gracefully.

(FR) Les tons intenses et les veines prononcées du nouveau parquet Dakota Oak confèrent une personnalité unique à chaque type de décoration, en la rendant imposante et accueillante.

Il se caractérise par une finition robuste et des couleurs profondes qui transmettent un charme très particulier, en créant des environnements intimes et pleins de caractère. Idéal pour ceux qui apprécient la beauté naturelle alliée à la force de l'expressivité, le chêne Dakota est le choix qui résiste à l'épreuve du temps et mûrit avec grâce.

Ref: 40.0518.001.018

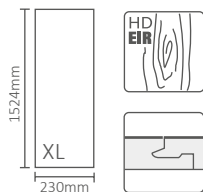
Perfis | Profiles | Profils  
Dakota OakRodapés | Skirtings | Plinthes  
Dakota OakEIR - Poro sincronizado  
EIR - Embossed in Register  
EIR - Pore synchroniséMicro Bisel  
Micro Bevel  
Micro BiseauVersão HERRINGBONE Pag: 29  
HERRINGBONE version Pag: 29  
Version à HERRINGBONE Pag: 29



Solid  CLICK XL

# SIGNATURE OAK

O novo padrão SIGNATURE OAK difunde a beleza mais pura do carvalho e combina o design sofisticado e a resistência incomparável da tecnologia SPC. Com uma tonalidade suave e acolhedora, foi desenvolvido para promover uma perfeita adaptação em qualquer estilo decorativo, desde os mais contemporâneos até os mais ancestrais, concedendo uma estética aprimorada e moderna, com a textura e o calor tão característicos do tom autêntico da madeira. A identidade que se sente a cada passo!

(EN) The new SIGNATURE OAK pattern diffuses the purest beauty of oak and combines the sophisticated design and the unparalleled strength of SPC technology. With a soft and welcoming tone, it was developed to promote a perfect fit to any kind of decorative style, from the most contemporary to the most ancient, providing an enhanced, modern aesthetic with the texture and warmth of its authentic wood tone. The identity that is felt at every step!

(FR) Le nouveau motif SIGNATURE OAK exhale la beauté pure du chêne et allie le design sophistiqué à la robustesse inégalée de la technologie SPC. Avec sa teinte douce et accueillante, il a été développé pour s'intégrer parfaitement à tous les styles de décoration, du plus contemporain au plus ancien, en offrant une esthétique moderne et raffinée grâce à la texture et à la chaleur de son ton authentique de bois. L'identité qui se ressent à chaque pas!

Ref: 40.0518.001.023

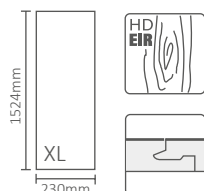

CAMADA DE DESGASTE  
0,7  
mm  
Wear Layer | Couche d'usure  
HD EIR



Perfis | Profiles | Profils  
Signature Oak



Rodapés | Skirtings | Plinthes  
Signature Oak



EIR- Poro sincronizado  
EIR- Embossed in Register  
EIR- Pore synchronisé



Micro Bisel  
Micro Bevel  
Micro Biseau

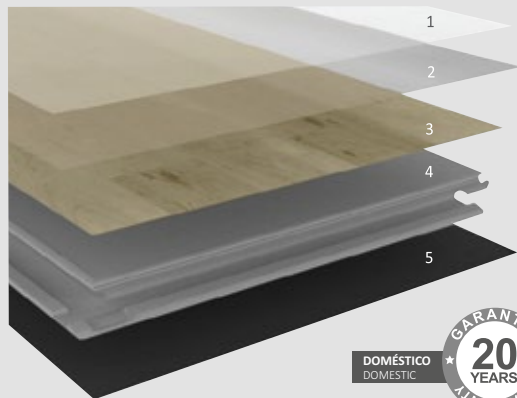

LEGENDA | LEGEND | LÉGENDE

- 1 Camada protetora PROTECTION PLUS tratamento anti-manchas e prot. UV  
PROTECTION PLUS Protective layer anti-stain treatment and UV protection  
Couche de protection PROTECTION PLUS traitement anti-taches et protection UV
- 2 Camada de desgaste - 0,7 mm  
Clear wear layer - 0,7 mm  
Couche d'usure - 0,7 mm
- 3 Filme impresso em alta qualidade e definição  
HD design print layer  
Couche d'impression HD
- 4 Núcleo rígido do SPC (sem orto-ftalato)  
Rigid SPC Core (Ortho-phthalates)  
Noyau CPS rigide (sans ortho-phthalate)
- 5 Tela de IXPE 1,5 mm  
1,5 mm IXPE underlay  
Sous-couche 1,5 mm IXPE



Tabela técnica | Technical table | Table technique

DIMENSÃO Size   Dimension (mm)	ESPESSURA Thickness   Épaisseur (mm)	PCS / CAIXA PCS / Boxes PCS / Boîtes	CAIXA Box   Boîte (m²)	CAIXA Box   Boîte (Kgs)	CAMADA DE DESGASTE Wear layer   Couche d'usure (mm)	CAIXAS/PALETE Boxes/Pallet Boîtes/Palette	PALETE Pallet / Palette (m²)
1524 x 230	6,5 1,5 Tela   Underlay   Sous-couche	5	1,7526	18,5	0,7	64	112,16

TESTE DE DESEMPENHO   ITEM TEST / TESTS DE PERFOR	NORMAS   STANDARDS   NORMES	RESULTADOS   RESULTS   RÉSULTATS
Tipo de Bisel   Bevel Type   Type de biseau		Bisel 4V   4V Bevel   Biseau 4V Micro Bisel   Micro Bevel   Micro Biseau
Camada de desgaste   Wear layer / Couche d'usure		0,7 mm
Nível de Uso   Usage Level   Niveau d'utilisation	EN 685	23/33/42
Estabilidade Dimensional   Dimensional stability   Stabilité dimensionnelle	ISO 23999:2018	Dir. X = 0.00%   Dir. Y = 0,05
Ondulação   Curling   Gondolage	ISO 23999:2018	0.00%
Classe de Abrasão   Abrasion Class   Classe d'abrasion	EN 660-2	Classe / Class P
Resistência à abrasão   Abrasion resistance   Résistance à l'abrasion	EN 13329:2016 Annex E	AC5
Resistência ao fogo   Fire resistance   Résistance au feu	EN 13501-1	Bfl-s1
Qualidade do ar interior   Indoor air quality   Qualité de l'air intérieur	ISO 16000	A+
COV ( Composto orgânico Volátil )   VOC ( Volatile Organic Compounds )	FloorScore	Aprovado   Approved   Approuvé
Metais pesados   Soluble heavy metal   Métaux lourds	ASTM F963-11	Aprovado   Approved   Approuvé
Isolamento ao ruído de impacto Impact noise insulation   Isolation contre le bruit d'impact	ISO 10140-3:2010	21dB
Indentação Residual   Residual Indentation   Indentation résiduelle	ASTM F1914-07   ASTM F1700-13a	0,1%
Resistência à carga estática   Static load resistance   Résistance à la charge statique	ASTM F970-15	0 mm
Emissão de formaldeído   Formaldehyde Emission   Emission de formaldéhyde	EN 717-1	E0
Tipo de Clique   Click Type   Type de clic		Uniclic 4 lados   4 sides   4 côtés
Absorção após submersão em água Absorption after submersion in water Absorption après immersion dans l'eau	EN 16511	0%
Resistência à exposição ao calor a 80°C / 180°F Heat exposure resistance 80°C/180°F Résistance à l'exposition à la chaleur à 80°C/ 180°F	ASTM 1700	Aprovado   Approved   Approuvé
TOLERÂNCIAS: TOLERANCES: TOLÉRANCES:	Espessura   Thickness   Épaisseur	+/-0,2mm
	Largura   Width   Largeur	+/-0,1mm
	Comprimento   Length   Longueur	+/-0,5mm
NÚCLEO: CORE: NOYAU:	Tipo de Núcleo   Core Type   Type de noyau	60% Pó de pedra + 20% PVC + 20% outros 60% Stone dust + 20% PVC + 20% others 60% Poudre de pierre + 20% PVC + 20% d'autres
	Espessura   Thickness   Épaisseur	4,3 mm
	Densidade   Density   Densité	≥ 2000Kg/m³
TELA DE ISOLAMENTO Isolation Underlay Sous-couche	Tipo   Type	IXPE
	Densidade   Density   Densité	132 Kg/m³
	Espessura   Thickness   Épaisseur	1,5 mm

(PT) Consulte as condições gerais de garantia em [gsfloors.pt](http://gsfloors.pt)  
A cor e padrão dos pavimentos pode variar para o produto original.

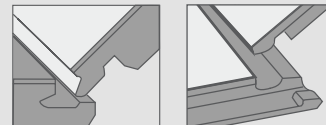
(EN) Please check the general guarantee conditions on [gsfloors.pt](http://gsfloors.pt)  
The colors and patterns of flooring can vary from the original product.

(FR) Consultez les conditions générales de garantie [gsfloors.pt](http://gsfloors.pt)  
La couleur et le motif de revêtements du parquet peut varier du produit original





# SPC | HERRINGBONE

CAMADA DE DESGASTE  
0,7  
mm  
Wear Layer | Couche d'usure

A nova gama de pavimento vinílico SPC | SOLID CLICK HERRINGBONE é uma coleção de aparência natural que incorpora tons elegantes e intemporais, semelhantes às mais belas madeiras, e com a sua tipologia de aplicação tradicionalmente designada “em espinha”, proporciona um resultado final verdadeiramente marcante e harmonioso! Surge como uma tendência que se tem revelado cada vez mais evidente e que conjuntamente com a sua aparência extra mate e tecnologia EIR harmonizam toda uma sensação de profundidade e movimento, enriquecendo o espaço com o seu visual aprimorado e repleto de personalidade.

(EN)

The new vinyl flooring SPC | SOLID CLICK HERRINGBONE is a natural-looking collection that incorporates elegant and timeless tones, similar to the most beautiful woods, and its herringbone pattern, provides a truly striking and harmonious result! It emerges as a trend that has become increasingly evident and along with its extra matte appearance and the EIR technology, recreates a whole sensation of depth and movement, optimizing the decor with its enhanced look. The perfect choice for those who's looking for a singular element.

(FR)

Le nouveau revêtement de sol en vinyle SPC | SOLID CLICK HERRINGBONE est une collection à l'aspect naturel qui intègre des tons élégants et intemporels, semblables aux plus belles essences de bois, et qui, grâce à sa typologie d'application en chevrons, offre un résultat vraiment saisissant et harmonieux ! Il s'agit d'une tendance de plus en plus évidente qui, avec son aspect extra mat et la technologie EIR, recrée toute une sensation de profondeur et de mouvement, en optimisant le décor grâce à son aspect amélioré. Le choix parfait pour ceux qui recherchent un élément singulier.

Solid   
Herringbone



Doméstico intenso  
Intense domestic  
Domestique intense



Comercial intenso  
Intense commercial  
Commercial intense



Industrial geral  
General industrial  
Commercial intense



Solid CLICK  
Herringbone

# ARABIAN OAK

HERRINGBONE

O padrão Arabian Oak Herringbone com a sua aplicação em espinha, não só valoriza todo o aspeto visual do ambiente, como também transmite um charme único, recriando uma verdadeira sensação de movimento e profundidade, tornando cada passo numa experiência distinta! Apresenta toda uma mística e intensidade que se manifestam na sua dinâmica estética e particularmente no seu toque e na beleza contrastante dos seus veios e nuances. O carisma e a personalidade juntos a potencializar qualquer tipo de decoração!

(EN) The pattern Arabian Oak Herringbone not only enhances the entire look of an environment, but also conveys a unique charm, recreating a true sensation of movement and depth, making each step a distinct experience! Its aesthetic dynamics manifest mystique and intensity, particularly in its touch and in the contrasting beauty of its veins and nuances. Charisma and personality together enhancing any type of decoration!

(FR) Le motif Arabian Oak Herringbone avec sa application à chevrons améliore non seulement l'aspect visuel global de l'environnement, mais transmet également un charme unique, en recréant une véritable sensation de mouvement et de profondeur, en faisant de chaque pas une expérience distincte ! Il présente une mystique et une intensité qui se manifestent dans sa dynamique esthétique et particulièrement dans son toucher et la beauté contrastée de ses veines et de ses nuances. Charisme et personnalité réunis pour sublimer tous les types de décoration!

Ref: 40.0518.004.015

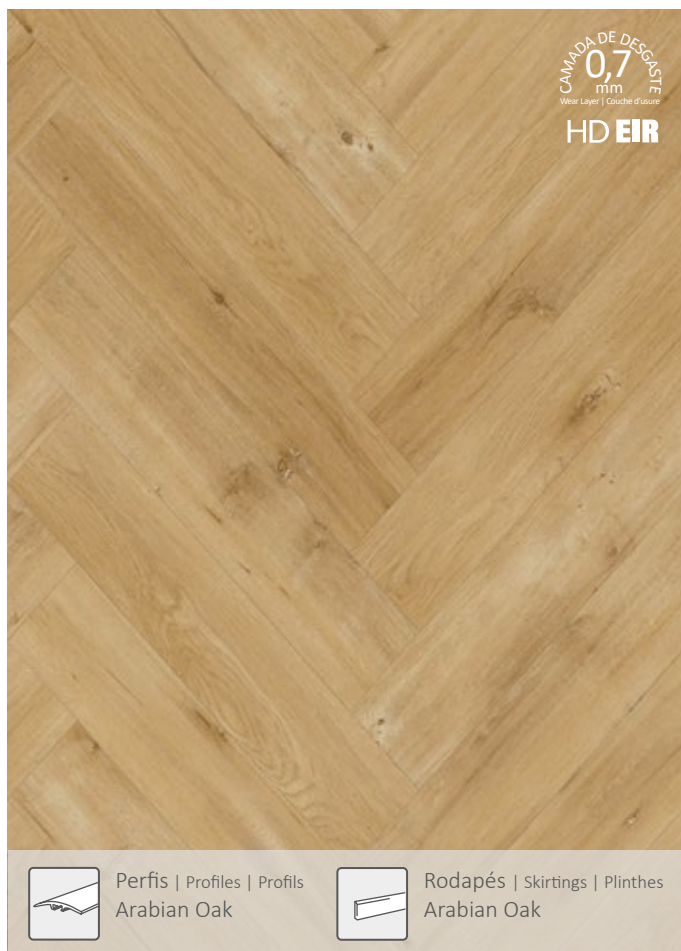
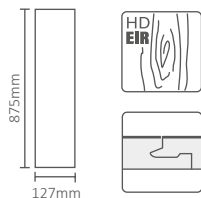

Perfis | Profiles | Profils  
Arabian Oak



Rodapés | Skirtings | Plinthes  
Arabian Oak



EIR - Poro sincronizado  
EIR - Embossed in Register  
EIR - Pore synchronisé



Micro Bisel  
Micro Bevel  
Micro Biseau



Solid CLICK  
Herringbone

## DAKOTA OAK HERRINGBONE

As tonalidades intensas e os veios marcantes do novo padrão Dakota Oak Herringbone conferem uma personalidade ímpar a cada espaço, tornando-o imponente e acolhedor.

A sua aplicação em espinha e a beleza do seu tom quente e autêntico do carvalho proporcionam um acabamento robusto e aconchegante, criando ambientes sofisticados e repletos de carácter. Ideal para quem aprecia a plenitude da natureza aliada à força da expressividade, o Dakota Oak é a eleição que resiste ao tempo e amadurece com graciosidade.

(EN) The intense hues and striking veins of the new Dakota Oak Herringbone pattern gives each space a unique personality, making it imposing and welcoming. The herringbone pattern and beauty of its warm and authentic oak tone provides a robust and cozy finish, creating sophisticated environments. Ideal for those who appreciate the fullness of nature combined with the strength of expressiveness, Dakota Oak is the election that resists time and matures gracefully.

(FR) Les teintes intenses et les veines frappantes du nouveau motif Dakota Oak Herringbone confèrent à chaque espace une personnalité unique, en le rendant imposant et accueillant. Son motif à chevrons et la beauté de sa teinte chêne chaleureuse et authentique offrent une finition robuste et chaleureuse, en créant des environnements sophistiqués. Idéal pour ceux qui apprécient la plénitude de la nature alliée à la force de l'expressivité, Dakota Oak est le choix qui résiste au temps et mûrit avec grâce.

Ref: 40.0518.004.018

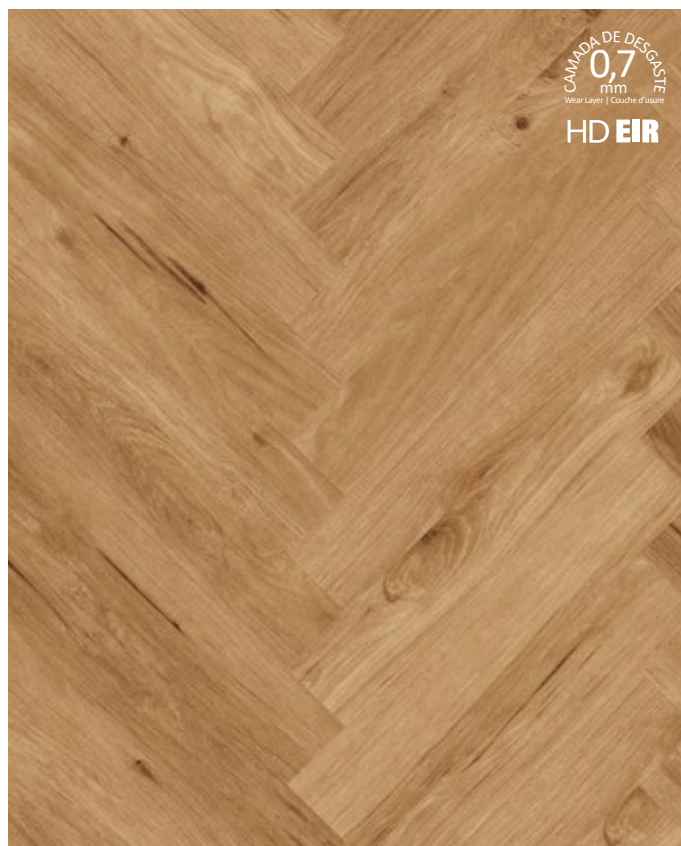
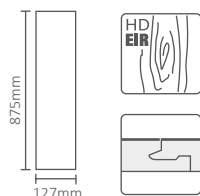

Perfis | Profiles | Profils  
Dakota Oak



Rodapés | Skirtings | Plinthes  
Dakota Oak



EIR- Poro sincronizado  
EIR- Embossed in Register  
EIR- Pore synchronisé



Micro Bisel  
Micro Bevel  
Micro Biseau

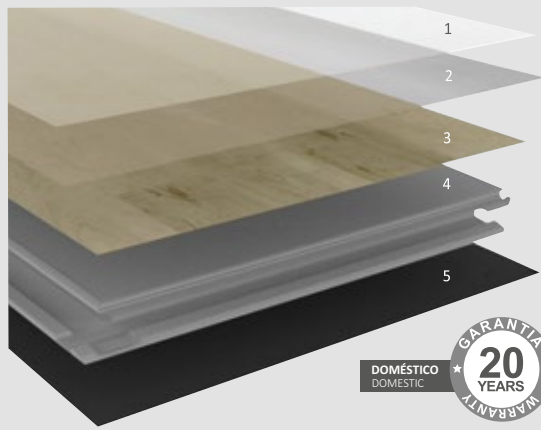

LEGENDA | LEGEND | LÉGENDE

- 1 Camada protetora PROTECTION PLUS tratamento anti-manchas e prot. UV**  
PROTECTION PLUS Protective layer anti-stain treatment and UV protection  
Couche de protection PROTECTION PLUS traitement anti-taches et protection UV
- 2 Camada de desgaste - 0,7 mm**  
Clear wear layer - 0,7 mm  
Couche d'usure - 0,7 mm
- 3 Filme impresso em alta qualidade e definição**  
HD design print layer  
Couche d'impression HD
- 4 Núcleo rígido do SPC (sem orto-ftalato)**  
Rigid SPC Core (Ortho-phthalates)  
Noyau CPS rigide (sans ortho-phthalate)
- 5 Tela de IXPE 1,5 mm**  
1,5 mm IXPE underlay  
Sous-couche IXPE 1.5 mm



Tabela técnica | Technical table | Table technique

DIMENSÃO Size   Dimension (mm)	ESPESSURA Thickness   Épaisseur (mm)	PCS / CAIXA PCS / Boxes PCS / Boîtes	CAIXA Box   Boîte (m²)	CAIXA Box   Boîte (Kgs)	CAMADA DE DESGASTE Wear layer   Couche d'usure (mm)	CAIXA/PALETE Boxes/Pallet Boîtes/Palette	PALETE Pallet   Palette (m²)
875 x 127	6,5 1,5 Tela   Underlay   Sous-couche	16	1,7728	18	0,7	60	106,68

TESTE DE DESEMPENHO   ITEM TEST / TESTS DE PERFOR		NORMAS   STANDARDS / NORMES	RESULTADOS   RESULTS / RÉSULTATS
Tipo de Bisel   Bevel Type   Type de biseau			Micro Bisel   Micro Bevel   Micro Biseau
Camada de desgaste   Wear layer / Couche d'usure			0,7 mm
Nível de Uso   Usage Level   Niveau d'utilisation		EN 685	23/33/42
Estabilidade Dimensional   Dimensional stability   Stabilité dimensionnelle		ISO 23999:2018	Dir. X = 0.00%   Dir. Y = 0,05
Ondulação   Curling   Gondolage		ISO 23999:2018	0.00%
Classe de Abrasão   Abrasion Class   Classe d'abrasion		EN 660-2	Classe / Class P
Resistência à abrasão   Abrasion resistance   Résistance à l'abrasion		EN 13329:2016 Annex E	AC5
Resistência ao fogo   Fire resistance   Résistance au feu		EN 13501-1	Bfl-s1
Qualidade do ar interior   Indoor air quality   Qualité de l'air intérieur		ISO 16000	A+
COV ( Composto orgânico Volátil )   VOC ( Volatile Organic Compounds )		FloorScore	Aprovado   Approved   Approuvé
Metais pesados   Soluble heavy metal   Métaux lourds		ASTM F963-11	Aprovado   Approved   Approuvé
Isolamento ao ruído de impacto Impact noise insulation   Isolation contre le bruit d'impact		ISO 10140-3:2010	21dB
Indentação Residual   Residual Indentation   Indentation résiduelle		ASTM F1914-07   ASTM F1700-13a	0,1%
Resistência à carga estática   Static load resistance   Résistance à la charge statique		ASTM F970-15	0 mm
Emissão de formaldeído   Formaldehyde Emission   Emission de formaldéhyde		EN 717-1	E0
Tipo de Clique   Click Type   Type de clic			Uniclic 4 lados   4 sides   4 côtés
Absorção após submersão em água Absorption after submersion in water Absorption après immersion dans l'eau		EN 16511	0%
Resistência à exposição ao calor a 80°C / 180°F Heat exposure resistance 80°C / 180°F Résistance à l'exposition à la chaleur à 80°C / 180°F		ASTM 1700	Aprovado   Approved   Approuvé
TOLERÂNCIAS: Tolerances: Tolérances:	Espessura   Thickness   Épaisseur		+/-0,2mm
	Largura   Width   Largeur		+/-0,1mm
	Comprimento   Length   Longueur		+/-0,5mm
NÚCLEO: Core: Noyau:	Tipo de Núcleo   Core Type   Type de noyau		60% Pó de pedra + 20% PVC + 20% outros 60% Stone dust + 20% PVC + 20% others 60% Poudre de pierre + 20% PVC + 20% d'autres
	Espessura   Thickness   Épaisseur		4,3 mm
	Densidade   Density   Densité		≥ 2000Kg/m³
TELA DE ISOLAMENTO Isolation Underlay Sous-couche	Tipo   Type		IXPE
	Densidade   Density   Densité		132 Kg/m³
	Espessura   Thickness   Épaisseur		1,5 mm

(PT) Consulte as condições gerais de garantia em [gsfloors.pt](http://gsfloors.pt)  
A cor e padrão dos pavimentos pode variar para o produto original.

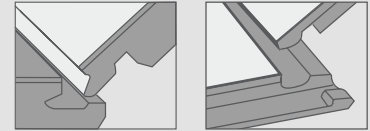
(EN) Please check the general guarantee conditions on [gsfloors.pt](http://gsfloors.pt)  
The colors and patterns of flooring can vary from the original product.

(FR) Consultez les conditions générales de garantie [gsfloors.pt](http://gsfloors.pt)  
La couleur et le motif de revêtements du parquet peut varier du produit original





# SPC | ACOUSTIC

CAMADA DE DESGASTE  
**0,7**  
 mm  
 Wear Layer | Couche d'usure

Desenvolvida com a mais avançada tecnologia de ponta, a nova gama de pavimento vinílico SPC | SOLID CLICK ACOUSTIC apresenta um desempenho excepcional tanto em termos de resistência como de conforto. Graças à sua estrutura robusta e à camada acústica integrada, esta coleção garante uma notável capacidade acústica e proporciona uma excelente relação entre a funcionalidade e o design. A escolha perfeita para quem procura uma solução inovadora e eficiente!

(EN)

Developed with the most advanced cutting-edge technology, the new SPC vinyl flooring | SOLID CLICK ACOUSTIC range offers exceptional performance in both resistance and comfort. Thanks to its robust structure and integrated acoustic layer, this collection guarantees remarkable acoustic capacity and provides an excellent balance between functionality and design. The perfect choice for those looking for an innovative and efficient solution!

(FR)

Développée avec la technologie de pointe la plus avancée, la nouvelle gamme de revêtements de sol en vinyle SPC | SOLID CLICK ACOUSTIC offre des performances exceptionnelles de résistance et de confort. Grâce à sa structure robuste et à sa couche acoustique intégrée, cette collection garantit une capacité acoustique remarquable et offre un excellent équilibre entre fonctionnalité et design. Le choix parfait pour ceux qui recherchent une solution innovante et efficace !

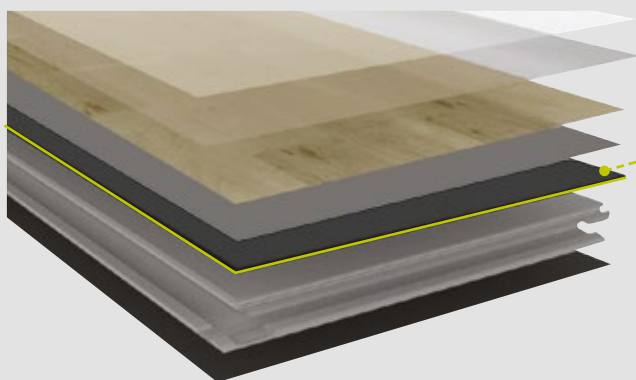

Sound Absorbent Layer  
 Sound absorbing layer | Couche d'absorption acoustique

Solid **CLICK**  
 Acoustic



Doméstico intenso  
 Intense domestic  
 Domestique intense



Comercial intenso  
 Intense commercial  
 Commercial intense



Industrial geral  
 General industrial  
 Commercial intense



Solid • ))  
CLICK  
Acoustic

## MYSTIC OAK

O novo padrão Mystic Oak com as suas características acústicas evidencia diferentes nuances que não só embelezam, como paralelamente proporcionam movimento ao espaço, transformando cada divisão numa atmosfera vibrante e singular. Este pavimento é uma celebração da natureza na sua forma mais pura. As tonalidades que se misturam, desde o claro ao escuro, concedem um panorama diferenciador, onde o pavimento é também uma obra de arte!

(EN) The new Mystic Oak flooring highlights the different nuances that not only beautifies, but also provides movement and dynamics, transforming each environment into a vibrant and unique atmosphere. This flooring is a celebration of nature on its purest form. The tones that mix, from light to dark, create a different panorama, where the floor is also a work of art!

(FR) Le nouveau sol Mystic Oak met en valeur les différentes nuances qui non seulement embellissent, mais apportent également du mouvement et de la dynamique, en transformant chaque environnement en une atmosphère vibrante et unique. Ce sol est une célébration de la nature dans sa forme la plus pure. Les tons qui se mélangent, du clair au foncé, créent un panorama différent, où le sol est aussi une œuvre d'art!

Ref: 40.0518.009.001

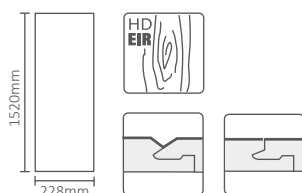



Solid  
CLICK  
Acoustic

# FOREST OAK

O novo Forest Oak apresenta um icónico padrão de carvalho numa aparência suave e quente, transmitindo uma sensação de serenidade e requinte, ideal para criar um ambiente pleno de luminosidade e com as suas excelentes características acústicas. Os veios naturais e a sua textura rica promovem um visual único, tornando-o numa solução multifuncional que se adapta a qualquer estilo de decoração.

A pretensão perfeita para projetos que respiram glamour e autenticidade, num elemento que se revela numa surpreendente fusão entre estética e funcionalidade.

(EN) The new Forest Oak features an iconic oak pattern on a soft, warm appearance, conveying a sense of serenity and refinement, ideal for creating a luminous environment. The natural veins and its rich texture promote a unique look, making it a multifunctional solution that adapts to any decor style. The perfect design for projects that promote glamour and authenticity, in an element that reveals a surprising fusion between aesthetics and functionality.

(FR) Le nouveau Forest Oak présente un motif emblématique en chêne sur un aspect doux et chaleureux, qui transmet une sensation de sérénité et de raffinement, idéal pour créer un environnement lumineux. Les veines naturelles et sa texture riche favorisent un look unique, en le rendant solution multifonctionnelle qui s'adapte à tous les styles de décoration. Le design parfait pour les projets qui promeuvent le glamour et l'authenticité, dans un élément qui révèle une fusion surprenante entre esthétique et fonctionnalité.

Ref: 40.0518.009.002

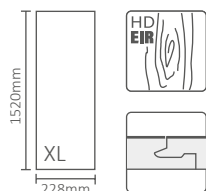

EIR- Poro sincronizado  
EIR- Embossed in Register  
EIR- Pore synchronisé



Micro Bisel  
Micro Bevel  
Micro Biseau



Solid   
CLICK  
Acoustic

# BOHEMIAN WALNUT

O pavimento Bohemian Walnut é a escolha manifesta para conseguir um ambiente sofisticado e apaixonante associado às suas excelentes características acústicas. O realismo dos seus veios e a sua tonalidade vibrante e intensa destacam a beleza única da madeira, tornando-a numa opção multifacetada que se concilia com diferentes gostos e preferências estéticas. Um pavimento eclético e fascinante, perfeito para dar vida e personalidade aos seus interiores. A elegância que perdura, num design intemporal.

(EN) The Bohemian Walnut flooring is the clear choice for creating a sophisticated and passionate environment. The realism of its veins and its vibrant tone highlight the unique beauty of the wood, making it a multifaceted option that suits different tastes and aesthetic preferences. An eclectic and fascinating flooring, perfect for giving life and personality to your interiors. Elegance that endures, in a timeless design.

(FR) Le sol Bohemian Walnut est le choix évident pour créer un environnement sophistiqué et passionné. Le réalisme de ses veines et son ton vibrant soulignent la beauté unique du bois, en le rendant une option multiforme qui convient à différents goûts et préférences esthétiques. Un revêtement de sol éclectique et fascinant, parfait pour donner vie et personnalité à vos intérieurs. Une élégance qui dure, dans un design intemporel.

Ref: 40.0518.009.003

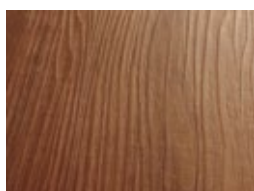

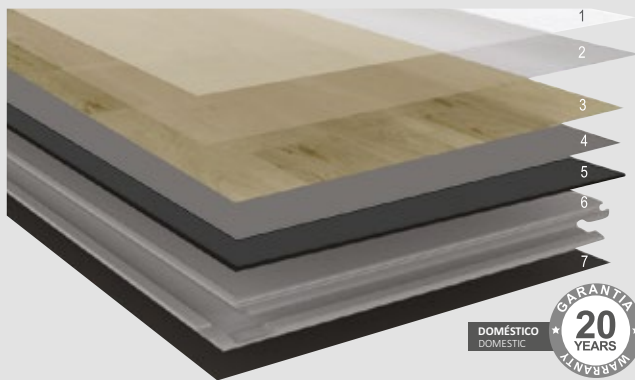

LEGENDA | LEGEND | LÉGENDE

- 1 Camada protetora PROTECTION PLUS tratamento anti-manchas e prot. UV  
PROTECTION PLUS Protective layer anti-stain treatment and UV protection  
Couche de protection PROTECTION PLUS traitement anti-taches et protection UV
- 2 Camada de desgaste - 0,7 mm  
Clear wear layer - 0,7 mm | Couche d'usure - 0,7 mm
- 3 Filme impresso em alta qualidade e definição  
HD design print layer | Couche d'impression HD
- 4 Núcleo rígido do SPC (sem orto-ftalato)  
Rigid SPC Core (Ortho-phthalates) | Noyau CPS rigide (sans ortho-phthalate)
- 5 Sound Absorbent Layer  
Sound absorbing layer | Couche d'absorption acoustique
- 6 Núcleo rígido do SPC (sem orto-ftalato)  
Rigid SPC Core (Ortho-phthalates) | Noyau CPS rigide (sans ortho-phthalate)
- 7 Tela de IXPE 1,5mm  
1,5 IXPE underlay | Sous-couche 1,5 mm IXPE



Tabela técnica | Technical table | Table technique

	DIMENSÃO Size   Dimension (mm)	ESPESSURA Thickness   Épaisseur (mm)	PCS / CAIXA PCS / Boxes PCS / Boîtes	CAIXA Box   Boîte (m²)	CAIXA Box   Boîte (Kgs)	CAMADA DE DESGASTE Wear layer   Couche d'usure (mm)	CAIXAS/ PALETE Boxes/Pallet Boîtes/Palette	PALETE Pallet/Palette (m²)
BISEL Bevel   Biseau	1520x228	8,5 1,5 Tela   Underlay   Sous-couche	4	1,3862	18,10	0,7	44	60,99
MICRO BISEL Micro Bevel   Micro Biseau	1520x228	9,5 1,5 Tela   Underlay   Sous-couche	4	1,3862	20,24	0,7	40	55,448

TESTES DE DESEMPENHO   test item   tests de performance	NORMAS   Standard   Normes	RESULTADOS   Results   Résultats
Tipo de Bisel   Bevel Type   Type de biseau		Bisel 4V   4V Bevel   Biseau 4V Micro Bisel   Micro Bevel   Micro Biseau
Camada de desgaste   Wear layer   Couche d'usure		0,7 mm
Tratamento de superfície   Surface treatment   Traitement de surface		( EIR ) Poro Sincronizado Embossed in Register   Embossage Synchronisé
Nível de Uso   Usage Level   Niveau d'utilisation	EN 685	23 33 42
Estabilidade Dimensional   Dimensional stability   Stabilité dimensionnelle	ISO 23999:2018	Dir. X= 0,00%   Dir. Y= 0,00%
Ondulação   Curling   Gondolage	ISO 23999:2018	0,00%
Classe de Abrasão   Abrasion Class   Classe d'abrasion	EN 660-2	Classe P
Resistência à abrasão   Abrasion resistance   Résistance à l'abrasion	EN 13329:2016 Annex E	AC5
Resistência ao fogo   Fire resistance   Résistance au feu	EN 13501-1	Bfl -s1
Qualidade do ar interior   Indoor air quality   Qualité de l'air intérieur	ISO 16000	A+
COV ( Composto orgânico Volátil )   VOC ( Volatile Organic Compounds )	FloorScore	Aprovado   Approved   Approuvé
Metais pesados   Soluble heavy metal   Métaux lourds	ASTM F963-11	Aprovado   Approved   Approuvé
Medição do isolamento acústico por via aérea Measurement of airborne sound insulation Mesure de l'isolation aux bruits aériens	ISO 10140-2:2021   ISO 717-1:2020	Rw=67 dB
Isolamento ao ruído de impacto Impact noise insulation   Isolation contre le bruit d'impact	ISO 10140-3:2021   ISO 717-2:2020	Lnw=41 dB
Isolamento ao ruído de impacto - Redução Impact noise insulation - Reduction   Isolation contre le bruit d'impact - Réduction	ISO 10140-1:2021   ISO 717-2:2020	ΔLw=20 dB
Indentação Residual   Residual Indentation   Indentation résiduelle	EN ISO 24343-1	≤ 0,10 mm
Resistência à carga estática   Static load resistance   Résistance à la charge statique	EN 1815:2016	0,1 KV
Emissão de formaldeído   Formaldehyde Emission   Emission de formaldéhyde	EN 717-1	E0
Tipo de Clique   Click Type   Type de clic		Uniclic 4 lados   4 sides   4 côtés
Absorção após submersão em água Absorption after submersion in water Absorption après immersion dans l'eau	EN 16511	0%
Condutividade Térmica   Thermal Conductivity   Conductivité thermique	EN 12664:2001	0,112 (W/mK)
Resistência Térmica   Thermal resistance   Résistance thermique	EN 12664:2001	0,078 (m².K)/W
Resistência à exposição ao calor a 80°C / 180°F Heat exposure resistance 80°C / 180°F Résistance à l'exposition à la chaleur à 80°C / 180°F	ASTM 1700	Aprovado   Approved   Approuvé
TOLERÂNCIAS: Tolerances: Tolérances:	Espessura   Thickness   Épaisseur	+/- 0.2mm
	Largura   Width   Largeur	+/- 0.1mm
	Comprimento   Length   Longueur	+/- 0.5mm
NÚCLEO Core Noyau	Tipo de Núcleo   Core Type   Type de noyau	60% Pó de pedra + 20% PVC + 20% outros 60% Stone dust + 20% PVC + 20% others 60% Poudre de pierre + 20% PVC + 20% d'autres
	Espessura   Thickness   Épaisseur	6.3 mm   7.3 mm
	Densidade   Density   Densité	≥ 2000kg/m³
TELA DE ISOLAMENTO Isolation Underlay Sous-couche	Tipo   Type	IXPE
	Densidade   Density   Densité	132 kg/m³
	Espessura   Thickness   Épaisseur	1.5mm

(PT) Consulte as condições gerais de garantia em [gsfloors.pt](http://gsfloors.pt)  
A cor e padrão dos pavimentos pode variar para o produto original.

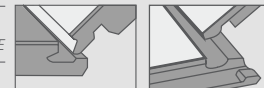
(EN) Please check the general guarantee conditions on [gsfloors.pt](http://gsfloors.pt)  
The colors and patterns of flooring can vary from the original product.

(FR) Consultez les conditions générales de garantie [gsfloors.pt](http://gsfloors.pt)  
La couleur et le motif de revêtements du parquet peut varier du produit original





# SPC | ESSENCE

A nova coleção de pavimento SPC | SOLID CLICK ESSENCE evidencia a combinação perfeita entre a nobreza do visual de madeira e a tecnologia SPC que garantem uma elevada resistência e durabilidade, com todas as vantagens de um pavimento vinílico.

Ideal para quem deseja um ambiente acolhedor e intemporal com a certeza de uma opção de distinta performance. A sofisticação da simplicidade e a robustez do SPC na solução adequada para unificar e revigorar toda uma decoração.

(EN)

The new SPC flooring collection | SOLID CLICK ESSENCE highlights the perfect combination between the nobility of the wood look and SPC technology that guarantees high resistance and durability, with all the advantages of a vinyl flooring.

Ideal for those who want a welcoming and timeless environment with the certainty of a distinct performance option. The sophistication of simplicity and the robustness of SPC in the right solution to unify and invigorate an entire decoration.

(FR)

La nouvelle collection de revêtements de sol SPC | SOLID CLICK ESSENCE met en valeur la combinaison parfaite entre la noblesse de l'aspect bois et la technologie SPC qui garantit une résistance et une durabilité élevées, avec tous les avantages d'un sol en vinyle.

Idéal pour ceux qui recherchent un environnement accueillant et intemporel avec la certitude d'une option de performance distincte. La sophistication de la simplicité et la robustesse du SPC dans la bonne solution pour unifier et dynamiser toute une décoration.



Doméstico intenso  
Intense domestic  
Domestique intense



Comercial intenso  
Intense commercial  
Commercial intense

Solid   
CLICK  
Essence



Solid   
Essence

# MYSTIC OAK

O novo padrão Mystic Oak evidencia diferentes nuances que não só embelezam, como paralelamente proporcionam movimento ao espaço, transformando cada divisão numa atmosfera vibrante e singular. Este pavimento é uma celebração da natureza na sua forma mais pura. As tonalidades que se misturam, desde o claro ao escuro, concedem um panorama diferenciador, onde o pavimento é também uma obra de arte!

(EN) The new Mystic Oak flooring highlights the different nuances that not only beautifies, but also provides movement and dynamics, transforming each environment into a vibrant and unique atmosphere. This flooring is a celebration of nature on its purest form. The tones that mix, from light to dark, create a different panorama, where the floor is also a work of art!

(FR) Le nouveau sol Mystic Oak met en valeur les différentes nuances qui non seulement embellissent, mais apportent également du mouvement et de la dynamique, en transformant chaque environnement en une atmosphère vibrante et unique. Ce sol est une célébration de la nature dans sa forme la plus pure. Les tons qui se mélangent, du clair au foncé, créent un panorama différent, où le sol est aussi une œuvre d'art!

Ref: 40.0518.007.001

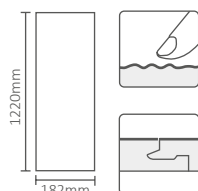

Perfis | Profiles | Profils  
Forest Oak



Rodapés | Skirtings | Plinthes  
Forest Oak

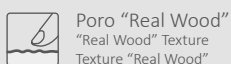

Poro "Real Wood"  
"Real Wood" Texture  
Texture "Real Wood"



Micro Bisel  
Micro Bevel  
Micro Biseau



Solid   
Essence

# FOREST OAK

O novo Forest Oak apresenta um icónico padrão de carvalho numa aparência suave e quente, transmitindo uma sensação de serenidade e requinte, ideal para criar um ambiente pleno de luminosidade. Os veios naturais e a sua textura rica promovem um visual único, tornando-o numa solução multifuncional que se adapta a qualquer estilo de decoração.

A pretensão perfeita para projetos que respiram glamour e autenticidade, num elemento que se revela numa surpreendente fusão entre estética e funcionalidade.

(EN) The new Forest Oak features an iconic oak pattern on a soft, warm appearance, conveying a sense of serenity and refinement, ideal for creating a luminous environment. The natural veins and its rich texture promote a unique look, making it a multifunctional solution that adapts to any decor style. The perfect design for projects that promote glamour and authenticity, in an element that reveals a surprising fusion between aesthetics and functionality.

(FR) Le nouveau Forest Oak présente un motif emblématique en chêne sur un aspect doux et chaleureux, qui transmet une sensation de sérénité et de raffinement, idéal pour créer un environnement lumineux. Les veines naturelles et sa texture riche favorisent un look unique, en le rendant une solution multifonctionnelle qui s'adapte à tous les styles de décoration. Le design parfait pour les projets qui promeuvent le glamour et l'authenticité, dans un élément qui révèle une fusion surprenante entre esthétique et fonctionnalité.

Ref: 40.0518.007.002

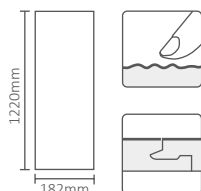

Perfis | Profiles | Profils  
Forest Oak



Rodapés | Skirtings | Plinthes  
Forest Oak



Poro "Real Wood"  
"Real Wood" Texture  
Texture "Real Wood"



Micro Bisel  
Micro Bevel  
Micro Biseau



Solid   
Essence

# BOHEMIAN WALNUT

O pavimento Bohemian Walnut é a escolha manifesta para conseguir um ambiente sofisticado e apaixonante. O realismo dos seus veios e a sua tonalidade vibrante e intensa destacam a beleza única da madeira, tornando-a numa opção multifacetada que se concilia com diferentes gostos e preferências estéticas. Um pavimento eclético e fascinante, perfeito para dar vida e personalidade aos seus interiores. A elegância que perdura, num design intemporal.

(EN) The Bohemian Walnut flooring is the clear choice for creating a sophisticated and passionate environment. The realism of its veins and its vibrant tone highlight the unique beauty of the wood, making it a multifaceted option that suits different tastes and aesthetic preferences. An eclectic and fascinating flooring, perfect for giving life and personality to your interiors. Elegance that endures, in a timeless design.

(FR) Le sol Bohemian Walnut est le choix évident pour créer un environnement sophistiqué et passionné. Le réalisme de ses veines et son ton vibrant soulignent la beauté unique du bois, en le rendant une option multiforme qui convient à différents goûts et préférences esthétiques. Un revêtement de sol éclectique et fascinant, parfait pour donner vie et personnalité à vos intérieurs. Une élégance qui dure, dans un design intemporel.

Ref: 40.0518.007.003

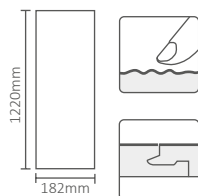

Perfis | Profiles | Profils  
Bohemian Walnut



Rodapés | Skirtings | Plinthes  
Bohemian Walnut



Poro "Real Wood"  
"Real Wood" Texture  
Texture "Real Wood"



Micro Bisel  
Micro Bevel  
Micro Biseau



Solid   
Essence

# ROYAL OAK

O novo padrão traduz a essência mais pura do carvalho, numa expressão elegante, sofisticada e subtilmente contemporânea. A sua aparência uniforme e natural envolve os espaços numa atmosfera serena e resplandecente, onde os tons suaves e delicados valorizam cada detalhe com equilíbrio e intemporalidade. A proposta ideal para criar ambientes distintos e acolhedores, onde a simplicidade se transforma numa verdadeira revelação de conforto e autenticidade.

(EN) The new design reveals the purest essence of oak through an elegant, sophisticated, and subtly contemporary expression. Its uniform, natural appearance envelops spaces in a serene and radiant atmosphere, where soft, delicate tones enhance every detail with balance and timeless appeal.

An ideal choice for creating distinctive and welcoming environments, where simplicity becomes a true expression of comfort and authenticity.

(FR) Le nouveau décor traduit l'essence la plus pure du chêne à travers une expression élégante, sophistiquée et subtilement contemporaine. Son aspect uniforme et naturel enveloppe les espaces d'une atmosphère sereine et lumineuse, où des tons doux et délicats valorisent chaque détail avec équilibre et intemporalité. Un choix idéal pour créer des intérieurs distinctifs et accueillants, où la simplicité devient une véritable expression de confort et d'authenticité.



Ref: 40.0518.007.004

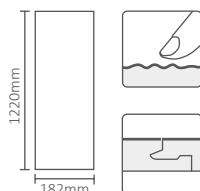

Perfis | Profiles | Profils  
Royal Oak



Rodapés | Skirtings | Plinthes  
Royal Oak



Poró "Real Wood"  
"Real Wood" Texture  
Texture "Real Wood"



Micro Bisel  
Micro Bevel  
Micro Biseau



Solid   
Essence

# HERITAGE OAK

Distinto pela expressividade dos seus veios e pelos detalhes nobres inspirados na madeira natural, este padrão revela uma estética singular e autêntica. Os seus tons de mel, quentes e encantadores, elevam qualquer ambiente com uma elegância serena, conciliando na perfeição linguagens decorativas modernas, clássicas ou românticas. Uma presença marcante que confere personalidade, charme e uma admirável sensação de bem-estar a cada espaço.

(EN) Expressive grain and refined wood-inspired detailing give this design a unique and authentic aesthetic. Warm honey tones elevate any room with a serene elegance integrating seamlessly into modern, classic, or romantic interiors. A striking presence that brings character, charm and a remarkable sense of well-being to every room.

(FR) Distinctif par l'expressivité de son veinage et ses détails raffinés inspirés du bois naturel, ce décor révèle une esthétique singulière et authentique. Ses tons miel, chaleureux et séduisants, apportent une élégance sereine qui sublime chaque espace, en parfaite harmonie avec des univers décoratifs modernes, classiques ou romantiques. Une présence affirmée qui insuffle personnalité, charme et une remarquable sensation de bien-être à chaque intérieur.



Ref: 40.0518.007.005

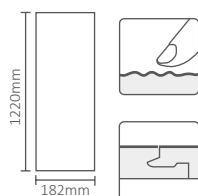

Perfis | Profiles | Profils  
Heritage Oak



Rodapés | Skirtings | Plinthes  
Heritage Oak

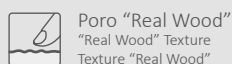

Poro "Real Wood"  
"Real Wood" Texture  
Texture "Real Wood"



Micro Bisel  
Micro Bevel  
Micro Biseau



Solid   
CLICK  
Essence

# WESTERN OAK

O novo padrão distingue-se pela intensidade das suas tonalidades e pela imponência dos seus veios, revelando uma aparência robusta e visualmente impactante. A densidade dos seus contrastes e a riqueza dos detalhes criam ambientes sofisticados e envolventes, onde a expressividade da madeira se destaca de forma distinta e marcante. Uma interpretação ousada do carvalho, concebida para espaços que privilegiam requinte, identidade e uma singularidade verdadeiramente intemporal.

(EN) The new design stands out through the intensity of its tones and the striking character of its grain, revealing a bold and visually compelling aesthetic. Deep contrasts and richly layered details create sophisticated and immersive spaces, where the expressiveness of wood emerges in a distinctive and remarkable way. An audacious interpretation of oak, designed for interiors that celebrate refinement, identity, and a truly timeless sense of uniqueness.

(FR) Le nouveau décor se distingue par l'intensité de ses tonalités et la présence affirmée de son veinage, en révélant une esthétique audacieuse et visuellement impactante. La profondeur de ses contrastes et la richesse de ses détails créent des espaces sophistiqués et immersifs, où l'expressivité du bois s'exprime de manière distincte et remarquable. Une interprétation audacieuse du chêne, pensée pour des intérieurs qui privilégient le raffinement, l'identité et une singularité véritablement intemporelle.

Ref: 40.0518.007.006

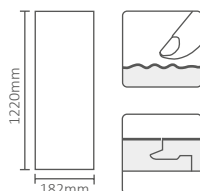

Perfis | Profiles | Profils  
Arabian Oak



Rodapés | Skirtings | Plinthes  
Arabian Oak



Poros "Real Wood"  
"Real Wood" Texture  
Texture "Real Wood"



Micro Bisel  
Micro Bevel  
Micro Biseau



Solid   
Essence

# URBAN OAK

Com uma estética contemporânea e urbana, o novo padrão destaca-se pela serenidade dos tons cinza e pela interpretação vanguardista do carvalho, conferindo profundidade e autenticidade a qualquer espaço. Uma solução versátil e elegante, pensada para criar ambientes modernos, luminosos e visualmente equilibrados, onde o minimalismo e o conforto coexistem em perfeita sintonia.

(EN) With a contemporary and urban aesthetic, the new design stands out through the serenity of its grey tones and its avant-garde interpretation of oak, bringing depth and authenticity to any space. A versatile and elegant solution, designed to create modern, bright and visually balanced environments, where minimalism and comfort coexist in perfect harmony.

(FR) Avec une esthétique contemporaine et urbaine, ce nouveau décor se distingue par la sérénité de ses tonalités grises et par son interprétation avant-gardiste du chêne, en apportant profondeur et authenticité à chaque espace. Une solution polyvalente et élégante, pensée pour créer des environnements modernes, lumineux et visuellement équilibrés, où minimalisme et confort coexistent en parfaite harmonie.

Ref: 40.0518.007.007

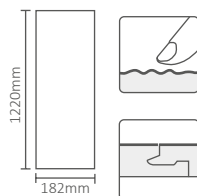

Perfis | Profiles | Profils  
Urban Oak



Rodapés | Skirtings | Plinthes  
Urban Oak



Poro "Real Wood"  
"Real Wood" Texture  
Texture "Real Wood"



Micro Bisel  
Micro Bevel  
Micro Biseau

LEGENDA | LEGEND | LÉGENDE

- 1 Camada protetora PROTECTION PLUS tratamento anti-manchas e prot. UV  
PROTECTION PLUS Protective layer anti-stain treatment and UV protection  
Couche de protection PROTECTION PLUS traitement anti-taches et protection UV
- 2 Camada de desgaste - 0,5 mm  
Clear wear layer - 0,5 mm  
Couche d'usure - 0,5 mm
- 3 Filme impresso em alta qualidade e definição  
HD design print layer  
Couche d'impression HD
- 4 Núcleo rígido do SPC (sem orto-ftalato)  
Rigid SPC Core (Ortho-phthalates)  
Noyau CPS rigide (sans ortho-phthalate)
- 5 Tela de IXPE 1,5 mm  
1,5 mm IXPE underlay  
Sous-couche 1,5 mm IXPE



Tabela técnica | Technical table | Table technique

DIMENSÃO Size   Dimension (mm)	ESPESSURA Thickness   Épaisseur (mm)	PCS / CAIXA PCS / Boxes PCS / Boîtes	CAIXA Box   Boîte (m²)	CAIXA Box   Boîte (Kgs)	CAMADA DE DESGASTE Wear layer   Couche d'usure (mm)	CAIXAS/ PALETE Boxes/Pallet Boîtes/Palette	PALETE Pallet / Palette (m²)
1220 x 182	6,5 1,5 Tela   Underlay   Sous-couche	8	1,776	18,76	0,5	50	88,81

TESTES DE DESEMPENHO   Test item   Tests de performance	NORMAS   Standard   Normes	RESULTADOS   Results   Résultats
Tipo de Bisel   Type of Bevel   Type de biseau		Micro Bisel   Micro Bevel   Micro Biseau
Tratamento de superfície   Surface treatment   Traitement de surface		Poros Real Wood Real wood Texture   Texture Real wood
Camada de desgaste   Wear layer   Couche d'usure		0,5 mm
Nível de Uso   Usage Level   Niveau d'utilisation	EN 685	23   33
Estabilidade Dimensional   Dimensional stability   Stabilité dimensionnelle	ISO 23999:2018	Dir. X= 0,05%   Dir. Y= 0,05%
Ondulação   Curling   Gondolage	ISO 23999:2018	0,50mm
Classe de Abrasão   Abrasion Class   Classe d'abrasion	EN 660-2	Classe P
Resistência à abrasão   Abrasion resistance   Résistance à l'abrasion	EN 13329:2016 Annex E	AC5
Resistência ao fogo   Fire resistance   Résistance au feu	EN 13501-1	Bfl -s1
Qualidade do ar interior   Indoor air quality   Qualité de l'air intérieur	ISO 16000	A+
COV ( Composto orgânico Volátil )   VOC ( Volatile Organic Compounds )	FloorScore	Aprovado   Approved   Approuvé
Metais pesados   Soluble heavy metal   Métaux lourds	ASTM F963-11	Aprovado   Approved   Approuvé
Isolamento ao ruído de impacto Impact noise insulation   Isolation contre le bruit d'impact	ISO 10140-3:2021   ISO 717-2:2020	L <sub>nw</sub> =21 dB
Indentação Residual   Residual Indentation   Indentation résiduelle	EN ISO 24343-1	≤ 0,10 mm
Resistência à carga estática   Static load resistance   Résistance à la charge statique	EN 1815:2016	0,1 KV
Emissão de formaldeído   Formaldehyde Emission   Emission de formaldéhyde	EN 717-1	E0
Tipo de Clique   Click Type   Type de clic		Uniclic 4 lados   4 sides   4 côtés
Absorção após submersão em água Absorption after submersion in water Absorption après immersion dans l'eau	EN 16511	0%
Condutividade Térmica   Thermal Conductivity   Conductivité thermique	EN 12664:2001	0,112 (W/mK)
Resistência Térmica   Thermal resistance   Résistance thermique	EN 12664:2001	0,058 (m <sup>2</sup> .K)/W
Resistência à exposição ao calor a 80°C / 180°F Heat exposure resistance 80°C / 180°F Résistance à l'exposition à la chaleur à 80°C / 180°F	ASTM 1700	Aprovado   Approved   Approuvé
TOLERÂNCIAS: Tolerances: Tolérances:	Espessura   Thickness   Épaisseur	+/- 0.2mm
	Largura   Width   Largeur	+/- 0.1mm
	Comprimento   Length   Longueur	+/- 0.5mm
NÚCLEO Core Noyau	Tipo de Núcleo   Core Type   Type de noyau	60% Pó de pedra + 20% PVC + 20% outros 60% Stone dust + 20% PVC + 20% others 60% Poudre de pierre + 20% PVC + 20% d'autres
	Espessura   Thickness   Épaisseur	4.5 mm
	Densidade   Density   Densité	≥ 2000kg/m <sup>3</sup>
TELA DE ISOLAMENTO Isolation Underlay Sous-couche	Tipo   Type	IXPE
	Densidade   Density   Densité	66 kg/m <sup>3</sup>
	Espessura   Thickness   Épaisseur	1.5mm

(PT) Consulte as condições gerais de garantia em gsfloors.pt  
A cor e padrão dos pavimentos pode variar para o produto original.

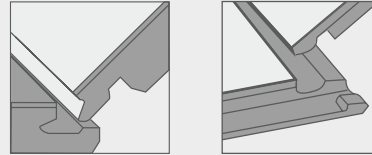
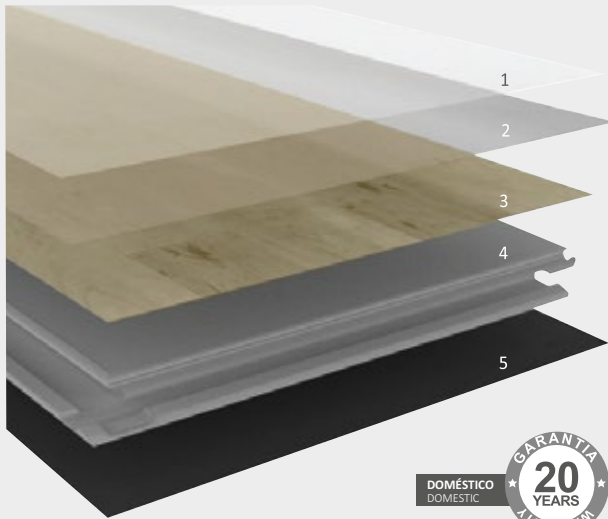
(EN) Please check the general guarantee conditions on gsfloors.pt  
The colors and patterns of flooring can vary from the original product.

(FR) Consultez les conditions générales de garantie gsfloors.pt  
La couleur et le motif de revêtements du parquet peut varier du produit original





# SPC | STONE

A nova gama de pavimento vinílico SPC | SOLID CLICK STONE revela-se numa verdadeira inspiração para quem procura a autenticidade dos visuais de pedra, que se retratam numa notável dinâmica estética, onde paralelamente a excelência da tecnologia SPC intensifica todas as suas especificidades. Os seus acabamentos recriam com precisão os detalhes das pedras naturais, concedendo uma sensação de luxo e elegância em qualquer projeto decorativo.

(EN)

The new line of SPC vinyl flooring | SOLID CLICK STONE is a true inspiration for those seeking authentic stone visuals, which are portrayed in a remarkable aesthetic dynamic, where, in parallel, the excellence of SPC technology intensifies all its specificities. All surfaces accurately recreate the details of natural stones, providing a sense of luxury and elegance to any decorative project.

(FR)

La nouvelle gamme de revêtements de sol en vinyle SPC | SOLID CLICK STONE est une véritable inspiration pour ceux qui recherchent des visuels de pierre authentiques, représentés dans une dynamique esthétique remarquable, où, en parallèle, l'excellence de la technologie SPC intensifie toutes ses spécificités. Ses finitions recréent avec précision les détails des pierres naturelles, apportant une sensation de luxe et d'élégance à n'importe quel projet décoratif.

Solid   
CLICK  
Stone



Doméstico intenso  
Intense domestic  
Domestique intense



Comercial intenso  
Intense commercial  
Commercial intense



Solid  CLICK  
Essence

# CALLACATTA

## Praliné

O novo pavimento Calacatta Praliné, com o seu padrão distinto é a escolha perfeita para quem valoriza qualidade e design ao mais alto nível, para uma atmosfera única e requintada.

Com os seus veios marcantes em tons de cinza e dourado sobre um fundo branco imaculado, confere uma beleza intemporal a qualquer ambiente. Ideal para salas de estar, casas de banho ou hall de entrada, o Calacatta transmite uma sensação de amplitude e carisma. O pavimento como protagonista da sua decoração!

(EN) The new Calacatta Praline flooring, with its distinct pattern is the perfect choice for those who value quality and design at the highest level, for a unique and refined atmosphere. With its striking veins in grey and gold shades on an immaculate white background, it brings timeless beauty to any environment. Ideal for living rooms, bathrooms or entrance halls. Calacatta conveys a sense of spaciousness and charisma. The flooring as the protagonist of your decoration!

(FR) Le nouveau sol Calacatta Praline, avec son motif distinctif, est le choix parfait pour ceux qui apprécient la qualité et le design au plus haut niveau, pour une atmosphère unique et raffinée. Avec ses veines frappantes des tons gris et or sur un fond blanc immaculé, il apporte une beauté intemporelle à n'importe quel environnement. Idéal pour salons, salles de bains ou halls d'entrée. Calacatta transmet une sensation d'espace et de charme. Le revêtement de sol comme protagoniste de votre décoration!

Ref: 40.0518.008.002

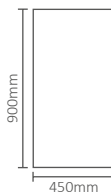



Solid 

# STONECRETE

O pavimento STONECRETE é uma solução moderna e versátil, excelente para quem procura projetos de design arrojados e carismáticos.

O seu visual combina facilmente com inúmeros estilos decorativos, permitindo uma maior elegância e harmonia, ao mesmo tempo que a textura do efeito de microcimento adiciona profundidade e sofisticação. A singularidade no detalhe e o conforto em cada passo!

(EN) STONECRETE flooring is a modern and versatile solution, excellent for those who's looking for dynamic and charismatic design projects. Its appearance easily combines with countless decorative styles, allowing for greater elegance and harmony, while the texture of the microcement effect adds depth and sophistication. Uniqueness in detail and comfort in every step!

(FR) Le sol STONECRETE est une solution moderne et polyvalente, idéale pour ceux qui cherchent des projets de design dynamiques et charismatiques. Son aspect se combine facilement avec d'innombrables styles décoratifs, en permettant une plus grande élégance et harmonie, tandis que la texture de l'effet microciment ajoute de la profondeur et de la sophistication. Unicité dans les détails et confort à chaque pas!

Ref: 40.0518.008.003

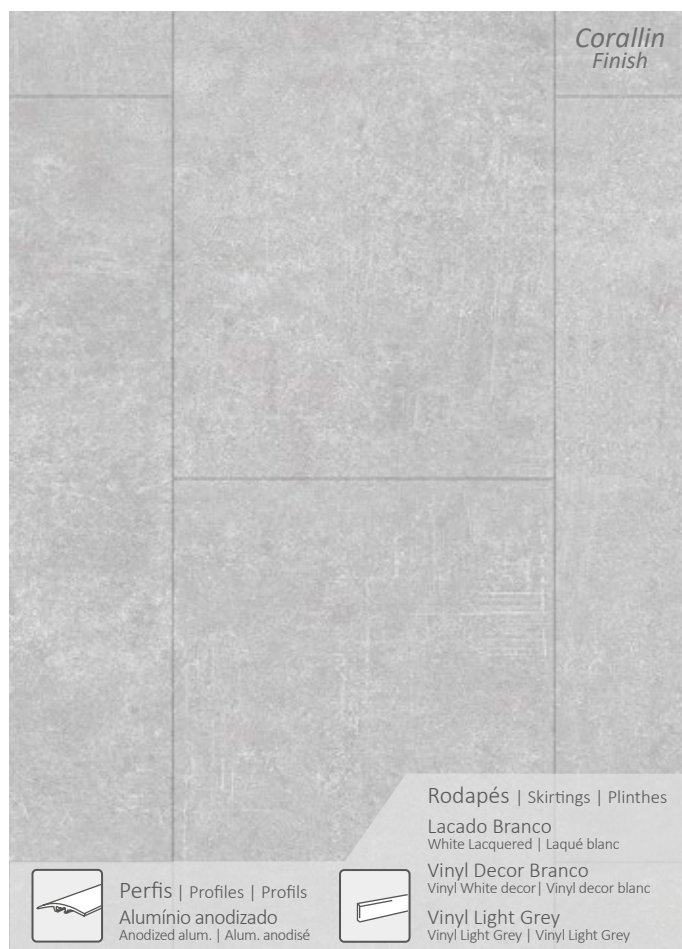
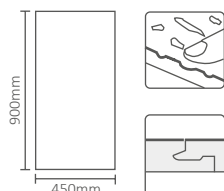

Corallin  
Finish

Rodapés | Skirtings | Plinthes

Lacado Branco  
White Lacquered | Laqué blanc

Vinyl Decor Branco  
Vinyl White decor | Vinyl decor blanc

Vinyl Light Grey  
Vinyl Light Grey | Vinyl Light Grey

 Perfis | Profiles | Profils  
Alumínio anodizado  
Anodized alum. | Alum. anodisé



Corallin  
Corallin  
Corallin



Micro Bisel  
Micro Bevel  
Micro Biseau



Solid   
CLICK  
Stone

## NOBLE MARBLE

O pavimento Noble Marble combina o encanto natural da pedra com a versatilidade necessária para se adaptar perfeitamente a diferentes tendências arquitetônicas, desde os mais clássicos aos mais contemporâneos. Traduz-se numa escolha refinada que proporciona atmosferas acolhedoras e elegantes, sendo perfeito para ambientes que requerem um toque de classe e estilo. Os veios delicados e irregulares conferem-lhe um carácter único, sendo a base perfeita para uma decoração inspiradora.

(EN) The Noble Marble flooring combines the natural charm of stone with the versatility needed to perfectly adapt to the different architectural trends, from the most classic to the most contemporary. It translates into a refined choice that provides welcoming and elegant atmospheres, making it perfect for environments that require a touch of class and style. The delicate and irregular veins give it a unique character, making it the perfect base for an inspiring decoration.

(FR) Le sol en Noble Marble allie le charme naturel de la pierre à la polyvalence nécessaire pour s'adapter parfaitement aux différentes tendances architecturales, des plus classiques aux plus contemporaines. Il s'agit d'un choix raffiné qui offre des atmosphères accueillantes et élégantes, ce qui le rend parfait pour les environnements qui nécessitent une touche de classe et de style. Les veines délicates et irrégulières lui confèrent un caractère unique, en étant la base parfaite pour une décoration inspirante.

Ref: 40.0518.008.001

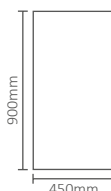

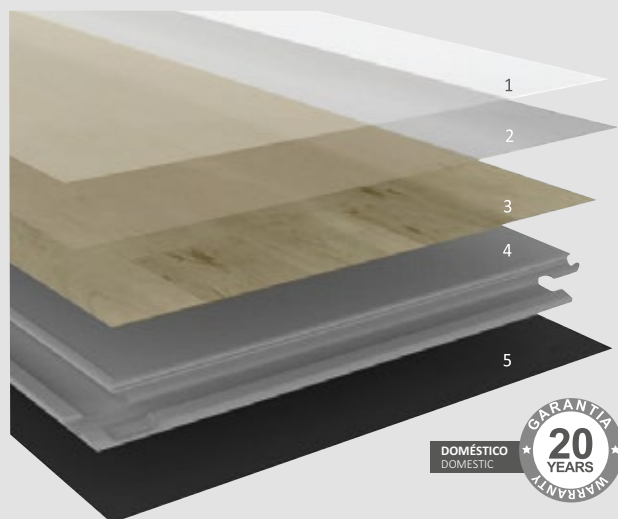

LEGENDA | LEGEND | LÉGENDE

- Camada protetora PROTECTION PLUS** tratamento anti-manchas e prot. UV  
*PROTECTION PLUS Protective layer anti-stain treatment and UV protection*  
*Couche de protection PROTECTION PLUS traitement anti-taches et protection UV*
- Camada de desgaste - 0,5 mm**  
*Clear wear layer - 0,5 mm*  
*Couche d'usure - 0,5 mm*
- Filme impresso em alta qualidade e definição**  
*HD design print layer*  
*Couche d'impression HD*
- Núcleo rígido do SPC (sem orto-ftalato)**  
*Rigid SPC Core (Ortho-phthalates)*  
*Noyau CPS rigide (sans ortho-phthalate)*
- Tela de IXPE 1,5 mm**  
*1,5 mm IXPE underlay*  
*Sous-couche 1,5 mm IXPE*



Tabela técnica | Technical table | Table technique

DIMENSÃO Size   Dimension (mm)	ESPESSURA Thickness   Épaisseur (mm)	PCS / CAIXA PCS / Boxes PCS / Boîtes	CAIXA Box   Boîte (m²)	CAIXA Box   Boîte (Kgs)	CAMADA DE DESGASTE Wear layer Couche d'usure	CAIXAS/ PALETE Boxes/Pallet Boîtes/Palette	PALETE Pallet/Palette (m²)
900x450	7,5 1,5 Tela   Underlay   Sous-couche	4	1,62	20,54	0,5	48	77,76

TESTES DE DESEMPENHO   Test item   Tests de performance	NORMAS   Standard   Normes	RESULTADOS   Results   Résultats
<b>Tipo de Bisel</b>   Bevel Type   Type de biseau		Micro Bisel   Micro Bevel   Micro Biseau
<b>Tratamento de superfície</b>   Surface treatment   Traitement de surface		Corallin
<b>Camada de desgaste</b>   Wear layer   Couche d'usure		0,5 mm
<b>Nível de Uso</b>   Usage Level   Niveau d'utilisation	EN 685	23 33
<b>Estabilidade Dimensional</b>   Dimensional stability   Stabilité dimensionnelle	ISO 23999:2018	Dir. X= 0,00%   Dir. Y= 0,10%
<b>Ondulação</b>   Curling   Gondolage	ISO 23999:2018	0,00%
<b>Classe de Abrasão</b>   Abrasion Class   Classe d'abrasion	EN 660-2	Classe P
<b>Resistência à abrasão</b>   Abrasion resistance   Résistance à l'abrasion	EN 13329:2016 Annex E	AC5
<b>Resistência ao fogo</b>   Fire resistance   Résistance au feu	EN 13501-1	Bfl -s1
<b>Qualidade do ar interior</b>   Indoor air quality   Qualité de l'air intérieur	ISO 16000	A+
<b>COV ( Composto orgânico Volátil )</b>   VOC ( Volatile Organic Compounds )	FloorScore	Aprovado   Approved   Approuvé
<b>Metais pesados</b>   Soluble heavy metal   Métaux lourds	ASTM F963-11	Aprovado   Approved   Approuvé
<b>Isolamento ao ruído de impacto</b> Impact noise insulation   Isolation contre le bruit d'impact	ISO 10140-3:2021   ISO 717-2:2020	Lnw=21 dB
<b>Indentação Residual</b>   Residual Indentation   Indentation résiduelle	EN ISO 24343-1	≤ 0,10 mm
<b>Resistência à carga estática</b>   Static load resistance   Résistance à la charge statique	EN 1815:2016	0,1 KV
<b>Emissão de formaldeído</b>   Formaldehyde Emission   Emission de formaldéhyde	EN 717-1	E0
<b>Tipo de Clique</b>   Click type   Type de clic		Uniclic 4 lados   4 sides   4 côtés
<b>Absorção após submersão em água</b> Absorption after submersion in water Absorption après immersion dans l'eau	EN 16511	0%
<b>Condutividade Térmica</b>   Thermal Conductivity   Conductivité thermique	EN 12664:2001	0,112 (W/mK)
<b>Resistência Térmica</b>   Thermal resistance   Résistance thermique	EN 12664:2001	0,058 (m2.K)/W
<b>Resistência à exposição ao calor a 80°C / 180°F</b> Heat exposure resistance 80°C / 180°F Résistance à l'exposition à la chaleur à 80°C / 180°F	ASTM 1700	Aprovado   Approved   Approuvé
<b>TOLERÂNCIAS:</b> Tolerances: Tolérances:	<b>Espessura</b>   Thickness   Épaisseur	+/- 0.2mm
	<b>Largura</b>   Width   Largeur	+/- 0.1mm
	<b>Comprimento</b>   Length   Longueur	+/- 0.5mm
<b>NÚCLEO</b> Core Noyau	<b>Tipo de Núcleo</b>   Core Type   Type de noyau	60% Pó de pedra + 20% PVC + 20% outros 60% Stone dust + 20% PVC + 20% others 60% Poudre de pierre + 20% PVC + 20% d'autres
	<b>Espessura</b>   Thickness   Épaisseur	5.5 mm
	<b>Densidade</b>   Density   Densité	≥ 2000kg/m³
<b>TELA DE ISOLAMENTO</b> Isolation Underlay Sous-couche	<b>Tipo</b>   Type	IXPE
	<b>Densidade</b>   Density   Densité	132 kg/m³
	<b>Espessura</b>   Thickness   Épaisseur	1.5mm

(PT) Consulte as condições gerais de garantia em [gsfloors.pt](http://gsfloors.pt)  
A cor e padrão dos pavimentos pode variar para o produto original.

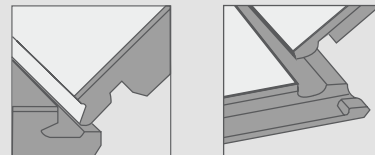
(EN) Please check the general guarantee conditions on [gsfloors.pt](http://gsfloors.pt)  
The colors and patterns of flooring can vary from the original product.

(FR) Consultez les conditions générales de garantie [gsfloors.pt](http://gsfloors.pt)  
La couleur et le motif de revêtements du parquet peut varier du produit original





## COMPLEMENTOS

COMPLEMENTS | COMPLÉMENTS

### Perfis de Escada

STAIR PROFILES | NEZ DE MARCHE

### RODAPÉS

SKIRTINGS | PLINTHES

### PERFIS DE REMATE

PROFILES | PROFILS

### TELAS DE ISOLAMENTO

ISOLATION UNDERLAY | SOUS COUCHES

PERFIS DE ESCADA SPC | SPC Stair Profiles | Nez de marche SPC

PERFIL DE ESCADA SPC SOLID CLICK XL

SPC SOLID CLICK XL Stair profile | Nez de marche SPC SOLID CLICK XL



1200 x 115 x 30 mm

Resistência | Resistance | Résistance :

- Classes | Class | Classe: 23 | 33 | 42

- Camada desgaste  
Wear layer | Couche d'usure 0,7 mm

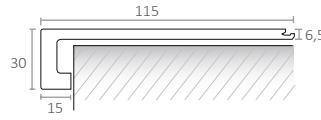
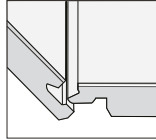

Para pavimento SPC SOLID CLICK XL  
For SPC SOLID CLICK XL flooring  
Pour lames SPC SOLID CLICK XL

SPC 2 Uni.

Comprimento | Length | Longueur: 1200 mm

Ref:	SPC   XL
43.0502.003.001	Honey Oak
43.0502.003.002	Smoked Oak
43.0502.003.003	Arizona Oak
43.0502.003.005	Iron Oak
43.0502.003.006	Graphite Oak
43.0502.003.022	Pearl Oak
43.0502.003.008	Vanilla Oak
43.0502.003.010	Riga Amber
43.0502.003.011	Riga Terracota
43.0502.003.012	Castle Oak 4V
43.0502.003.013	Ivory Oak 4V
43.0502.003.014	Arabian Oak 4V

\* LIMITADO AO STOCK EXISTENTE. | Limited to existing stock | Limité au stock existant

PERFIL DE ESCADA SPC SOLID CLICK XL - NOVO MODELO

SPC SOLID CLICK XL Stair profile - New Model | Nez de marche SOLID CLICK XL - Nouveau modèle



1510 x 168 x 30 mm

Resistência | Resistance | Résistance :

- Classes | Class | Classe: 23 | 33 | 42

- Camada desgaste  
Wear layer | Couche d'usure 0,7 mm

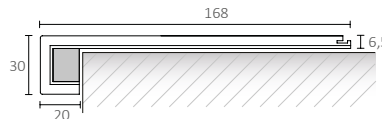
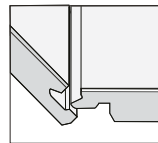

Para pavimento SPC SOLID CLICK XL  
For SPC SOLID CLICK XL flooring  
Pour lames SPC SOLID CLICK XL

SPC 2 Uni.

Comprimento | Length | Longueur: 1510 mm

Ref:	SPC   XL
43.0502.006.001	Honey Oak
43.0502.006.002	Smoked Oak
43.0502.006.003	Arizona Oak
43.0502.006.004	Nature Oak
43.0502.006.005	Iron Oak
43.0502.006.006	Graphite Oak
43.0502.006.007	Pearl Oak
43.0502.006.008	Vanilla Oak
43.0502.006.010	Riga Amber
43.0502.006.011	Riga Terracota
43.0502.006.012	Castle Oak
43.0502.006.013	Ivory Oak
43.0502.006.014	Arabian Oak
43.0502.006.016	Harvest Oak
43.0502.006.017	Coyote Oak
43.0502.006.018	Dakota Oak
43.0502.006.019	Havana Oak
43.0502.006.020	Barley Oak
43.0502.006.023	Signature Oak

PERFIL DE ESCADA SPC SOLID CLICK ACOUSTIC

SPC SOLID CLICK ACOUSTIC Stair profile | Nez de marche SPC SOLID CLICK ACOUSTIC



1500 x 163 x 30 mm

Resistência | Resistance | Résistance :

- Classes | Class | Classe: 23 | 33 | 42

- Camada desgaste  
Wear layer | Couche d'usure 0,7 mm

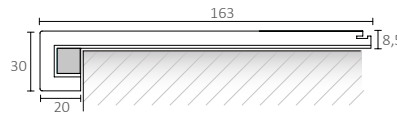
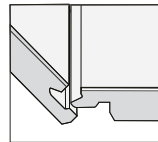

Para pavimento SPC SOLID CLICK ACOUSTIC  
For SPC SOLID CLICK ACOUSTIC flooring  
Pour lames SPC SOLID CLICK ACOUSTIC

SPC 2 Uni.

Comprimento | Length | Longueur: 1500 mm

Ref:	SPC   ACOUSTIC
43.0502.005.001	Mystic Oak
43.0502.005.002	Forest Oak
43.0502.005.003	Bohemian Walnut

PERFIL DE ESCADA SOLID CLICK ESSENCE

SPC SOLID CLICK ESSENCE Stair profile | Nez de marche SPC SOLID CLICK ESSENCE



1220 x 120 x 30 mm

Resistência | Resistance | Résistance :

- Classes | Class | Classe: 23 | 33 | 42

- Camada desgaste  
Wear layer | Couche d'usure 0,5 mm

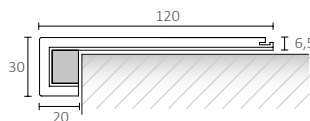
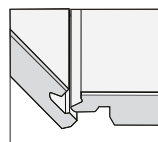

Para pavimento SPC SOLID CLICK ESSENCE  
For SPC SOLID CLICK ESSENCE flooring  
Pour lames SPC SOLID CLICK ESSENCE

SPC 2 Uni.

Comprimento | Length | Longueur: 1220 mm

Ref:	SPC   ESSENCE
43.0502.004.001	Mystic Oak
43.0502.004.002	Forest Oak
43.0502.004.003	Bohemian Walnut
43.0502.004.004	Royal Oak
43.0502.004.005	Heritage Oak
43.0502.004.006	Western Oak
43.0502.004.007	Urban Oak

## PERFIS DE ESCADA | SPC SOLID CLICK | VANTAGENS E TIPOS DE APLICAÇÃO!

SPC SOLID CLICK Stair profiles | Advantages and Application Types  
Nez de marche SPC SOLID CLICK | Avantages et types d'application



Modelo utilizado na imagem:  
Model used in the image | Modèle utilisé dans l'image

**PERFIL DE ESCADA - SPC XL**  
SPC XL - Stair profile | Nez de marche - SPC XL



**Situação em obra:**  
Situation on site | Situation sur place

**1 TOPO À VISTA - SEM ESPELHO**  
Open 1 side - without riser | 1 côté ouvert - sans contremarche

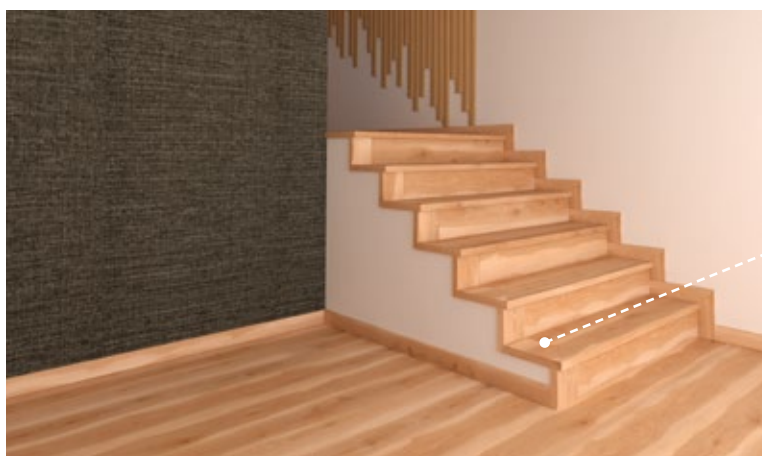

Modelo utilizado na imagem:  
Model used in the image | Modèle utilisé dans l'image

**PERFIL DE ESCADA - SPC ESSENCE**  
SPC ESSENCE - Stair profile | Nez de marche - SPC ESSENCE



**Situação em obra:**  
Situation on site | Situation sur place

**1 TOPO À VISTA - COM ESPELHO**  
Open 1 side - with riser | 1 côté ouvert - avec contremarche

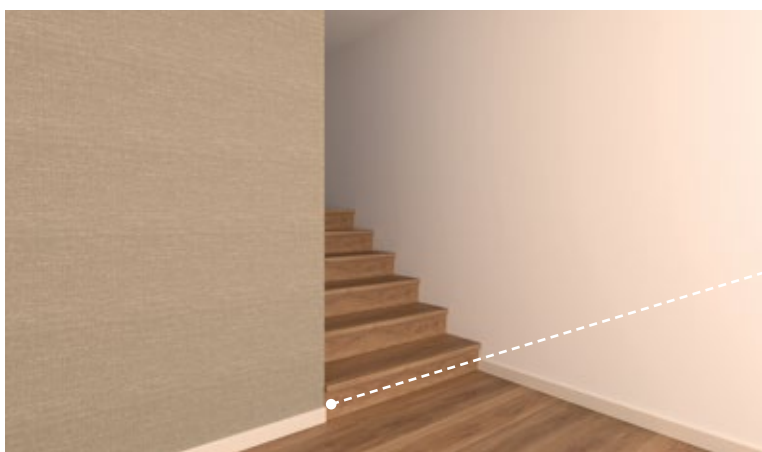

Modelo utilizado na imagem:  
Model used in the image | Modèle utilisé dans l'image

**PERFIL DE ESCADA - SPC ACOUSTIC**  
SPC ACOUSTIC - Stair profile | Nez de marche - SPC ACOUSTIC

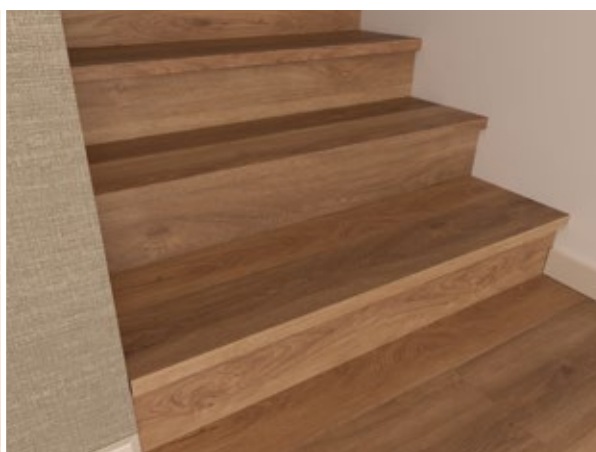

**Situação em obra:**  
Situation on site | Situation sur place

**ENTRE PAREDES (COM OU SEM ESPELHO)**  
Between walls (with or without riser) | Entre murs (avec ou sans contremarche)

**RODAPÉ WPC**  
WPC skirting board | Plinthe en WPC

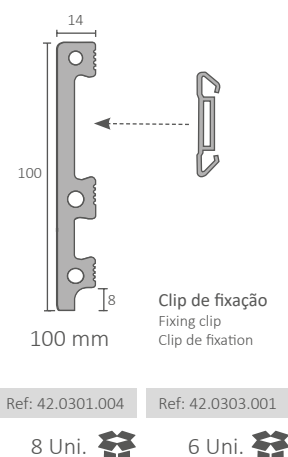

**Comprimento** | Length | Longueur:  
2500 mm  
**Altura** | Height | Hauteur:  
70 | 100 mm  
**Espessura** | Thickness | Épaisseur:  
14 mm  
**Densidade** | Density | Densité:  
800 Kgs/m<sup>3</sup>

**Material de base** | Made of | Fabriqué en:  
Compósito de madeira e plástico (WPC)  
Wood and plastic composite (WPC)  
Composite de bois et plastique (WPC)

**Revestimentos disponíveis:**  
Available Coatings | Revêtements disponibles:  
Folha PVC | PVC Foil | Feuille de PVC: (180µ)  
Folha Decor | Decor Foil | Feuille Decor: (180 µ)  
Folha Vinil | Vinyl | Vinyle: (120- 150 µ)



Rodapé fabricado em compósito de madeira e plástico (PVC), de elevada resistência à humidade e de fácil manutenção. Indicado para aplicação em pavimentos cerâmicos, vinílicos e flutuantes. Devido à flexibilidade do WPC, este rodapé pode ser instalado em superfícies curvas.

(EN) - Skirting manufactured in wood and plastic composite (PVC) with highly moisture-resistant and easy to maintain. The WPC skirting is indicated for ceramic, vinyl and floating floorings. Due to the WPC flexibility, this skirting can be installed on curved surfaces.

(FR) - Plinthe fabriquée en composite de bois et plastique (PVC), très résistant à l'humidité et facile à entretenir. Indiqué pour l'application dans des planchers en céramique, en vinyle et flottants. Grâce à la flexibilité du WPC, cette plinthe peut être installée sur des surfaces courbes.

**TIPOS DE APLICAÇÃO POSSÍVEIS** | Possible types of application | Types d'application possibles



**1** Fixação com clip de fixação\*  
Clamping clip  
Clip de fixation



**2** Cola Prego | Cola e veda  
Adhesive and sealant  
Colle-mastic



**3** Espuma adesiva rápida PU (baixa expansão)  
PU adhesive foam - low expansive  
Mousse adhésive PU - faible expansion

\*Apenas rodapé 100x14mm | 100x14mm skirting board only | Juste pour plinthe en WPC 100x14mm

(Distância recomendada entre cliques: cerca de 500 mm) (Recommended distance between clips: about 500 mm) | (Distance recommandée entre les clips : environ 500 mm)

Inclui parafuso tapit | Nail anchors include | Inclus chevilles invisibles

**RODAPÉ DE SOBREPOSIÇÃO XPS**  
XPS overlay skirting board | Plinthe recouvrir XPS

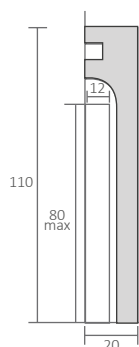

**Comprimento** | Length | Longueur:  
2400 mm  
**Altura** | Height | Hauteur:  
110 mm  
**Espessura** | Thickness | Épaisseur:  
20 mm  
**Densidade** | Density | Densité:  
500 ± 20Kg/m<sup>3</sup>

**Material de base** | Made of | Fabriqué en:  
XPS | Poliestireno (96% de matéria-prima)  
XPS | Polystyrene (96% raw material)  
XPS | Polystyrène (96% de matière première)

**Cores disponíveis:**  
Available Colours | Couleurs disponibles:

Lacado Branco | Lacado cor RAL mate  
White Lacquered | Lacquered matte RAL color  
Laqué Blanc | Laqué en couleur RAL mat

Sobreposição de até 80 mm de altura e 12 mm de espessura.  
Overlay up to 80 mm in height and thickness 12 mm.  
Recouvrir jusqu'à 80 mm de hauteur et 12 mm d'épaisseur.



Ref: 42.0302.002

11 Uni.

## RODAPÉ DE ALUMÍNIO

Aluminium skirting board | Plinthe en aluminium

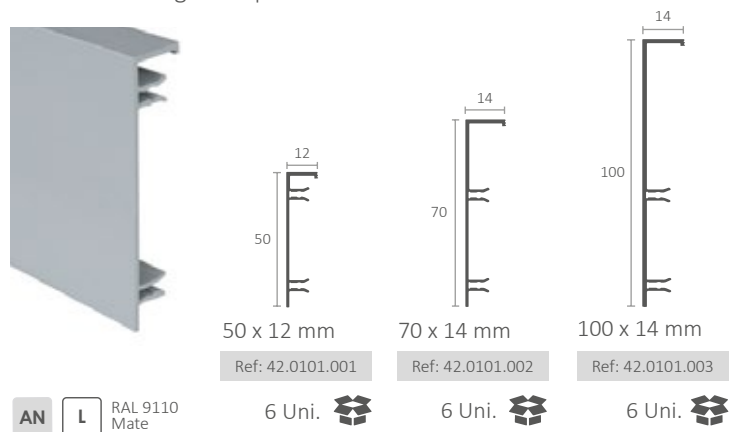

Comprimento | Length | Longueur: 2500 mm

## Clip de rodapé de alumínio

Skirting board clip | Plinthe clip

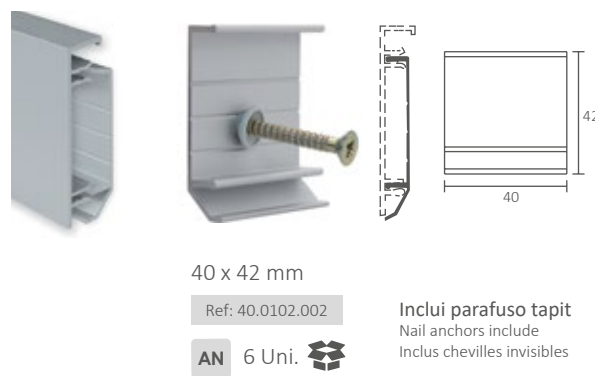

Comprimento | Length | Longueur: 40 mm

Inclui parafuso tapit  
Nail anchors include  
Inclus chevilles invisibles

Distância recomendada entre cliques: cerca de 500 mm | Recommended distance between clips: about 500 mm | Distance recommandée entre les clips : environ 500 mm)

O rodapé de alumínio GS FLOORS é elegante, minimalista e de enorme qualidade. Aplicado em conjunto com o clip de fixação, confere bastante segurança na sua utilização e aderência à parede. Permite armazenar fios e cabos de serviço, ocultando-os da vista, proporcionando uma maior harmonia estética.

(EN) - The GS FLOORS aluminium skirting board is elegant, minimalist and of high quality. Applied together with the fixing clip, it provides high security in its use and adherence to the wall. It allows to hide service wires and cables, providing greater aesthetic harmony.

(FR) - La plinthe en aluminium GS FLOORS est élégante, minimaliste et de grande qualité. Appliquée avec le clip de fixation, elle offre beaucoup de sécurité dans son utilisation et son adhérence au mur. Elle permet de ranger les fils et câbles de service, en les cachant de la vue, en offrant une plus grande harmonie esthétique.

## CANTOS PARA RODAPÉ DE ALUMÍNIO

Corners for aluminium skirting | Coins pour plinthe en aluminium

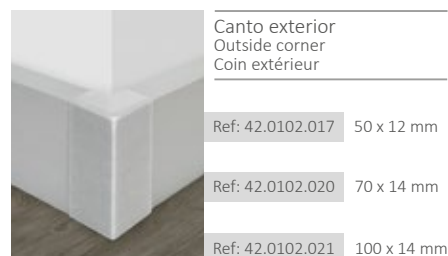

ABS **C** **L**

1 Uni.

ABS **C** **L**

1 Uni.

ABS **C** **L**

1 Uni.

## RODAPÉ DE EMBUTIR ALUMÍNIO

Wall flush aluminium skirting | Plinthe invisible en aluminium

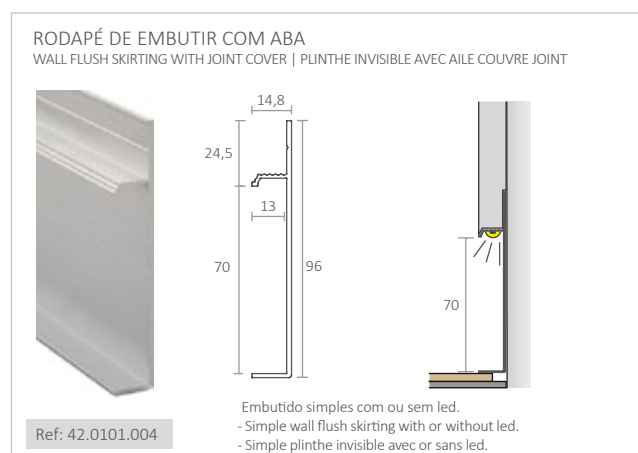

Comprimento | Length | Longueur: 2500 mm

AN **L** 1 Uni.

Fita led (não incluída).  
Led strip (not included).  
Bande led (non inclus).

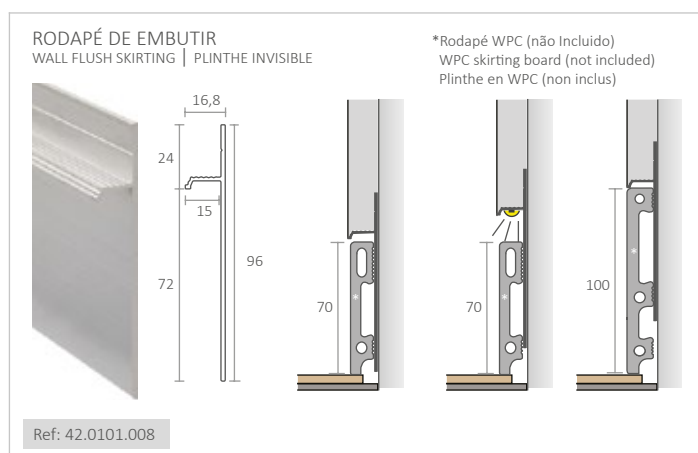

Comprimento | Length | Longueur: 2500 mm

AN **L** 1 Uni.

(Rodapé WPC Opcional)  
(WPC skirting optional)  
(Plinthe WPC Optionnel)

SÉRIE ALUMÍNIO SPC | SPC Aluminium Serie | Serie Aluminium SPC

PERFIL DE TRANSIÇÃO  
Transition profile | Profil de transition

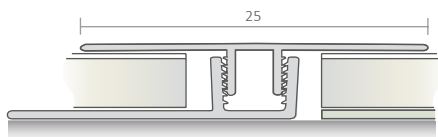

Ref: 43.0102.004

25mm



Comprimento | Length | Longueur: 2500 mm

AN SPC PVC

10 Uni.

PERFIL TERMINAL  
Edge profile | Profil d'arrêt

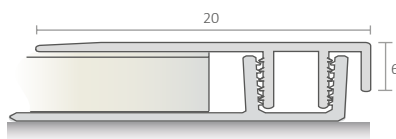
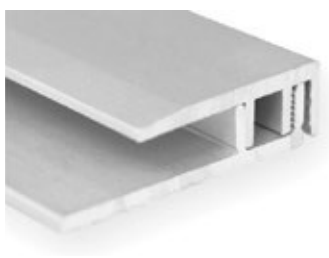

Ref: 43.0201.002

20mm



Comprimento | Length | Longueur: 2500 mm

AN SPC PVC

10 Uni.

PERFIL DESNÍVEL  
Adaptation profile | Profil d'adaptation

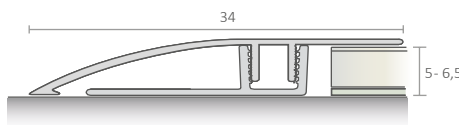
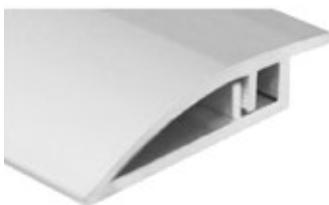

Ref: 43.0302.004

34mm



Comprimento | Length | Longueur: 2500 mm

AN SPC PVC

10 Uni.

Para a aplicação com o pavimento SPC | SOLID CLICK ACOUSTIC utilizar o Perfil de Desnível 46 mm (Ref: 43.0302.001 - Pág. 51)  
- For SOLID CLICK ACOUSTIC | SPC flooring installation, use the 46 mm Adaptation profile (Ref: 43.0302.001- Page 51)  
- Pour application avec revêtement de sol SPC | SOLID CLICK ACOUSTIC, utilisez le Profil d'adaptation 46 mm (Réf. : 43.0302.001- Page 51)

BASE ALUMÍNIO  
Aluminium base | Base en aluminium

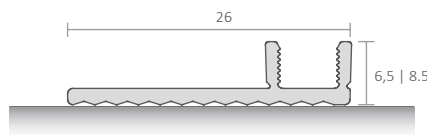

Ref: 43.0602.003

Para pavimentos de 5 a 7,5 mm  
For floorings from 5 to 7,5 mm  
Pour des sols de 5 à 7,5 mm

Ref: 43.0602.004

Para pavimentos de 8,5 a 10 mm  
For floorings from 8,5 to 10 mm  
Pour des sols de 8,5 à 10 mm

Comprimento | Length | Longueur: 2500 mm

AB

10 Uni.

Os perfis de remate em alumínio foram desenvolvidos para possibilitar uma transição perfeita entre as juntas no pavimento. Proporcionam um encaixe perfeito e um resultado final esteticamente atrativo. Acabamento em alumínio ou revestimento com lâminas decorativas nas cores e padrões das gamas de pavimento SOLID CLICK SPC.

(EN)- The aluminum finishing profiles have been developed to enable a seamless transition between the joints of the flooring. They provide a perfect fit and a very attractive aesthetical result. In anodized aluminum finish or coated in the same decors and patterns of the SOLID CLICK SPC flooring ranges.

(FR)- Les profils de finition de l'aluminium ont été développés pour permettre une transition parfaite entre les joints du parquet. L'ajustement parfait permet un résultat final esthétiquement attrayant. Finition en aluminium ou en revêtement avec des couleurs et des motifs de SOLID CLICK SPC gammes de revêtements de sol.

SÉRIE ALUMÍNIO COM BASE PVC | PVC Base - Aluminium Serie | Serie Aluminium avec base en PVC

PERFIL DE TRANSIÇÃO  
Transition profile | Profil de transition

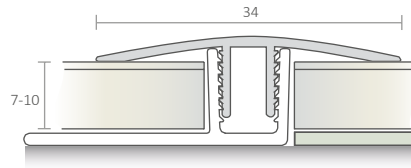

Ref: 43.0102.001

34mm

Para pavimentos até 10 mm  
For floorings until 10 mm  
Pour des sols jusqu'à 10 mm

AN PVC

10 Uni.

Comprimento | Length | Longueur: 2500 mm

PERFIL DE TRANSIÇÃO  
Transition profile | Profil de transition

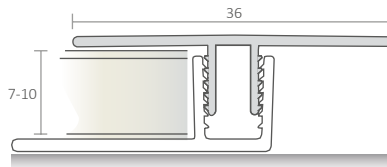

Ref: 43.0102.002

36mm

Para pavimentos até 10 mm  
For floorings until 10 mm  
Pour des sols jusqu'à 10 mm

AN PVC

10 Uni.

Comprimento | Length | Longueur: 2500 mm

PERFIL DESNÍVEL  
Adaptation profile | Profil d'adaptation

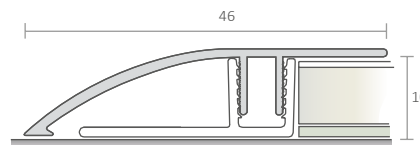
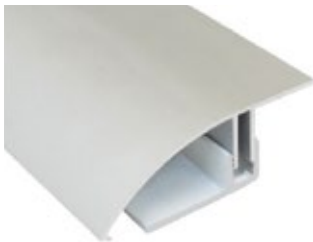

Ref: 43.0302.001

46mm

Para pavimentos até 10 mm  
For floorings until 10 mm  
Pour des sols jusqu'à 10 mm

AN PVC

10 Uni.

Comprimento | Length | Longueur: 2500 mm

PERFIL DESNÍVEL  
Adaptation profile | Profil d'adaptation

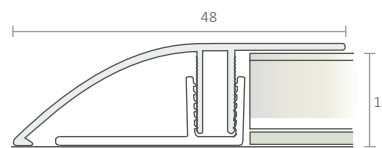

Ref: 43.0302.002

48mm

Para pavimentos até 12 mm  
For floorings until 12 mm  
Pour des sols jusqu'à 12 mm

AN PVC

10 Uni.

Comprimento | Length | Longueur: 2500 mm

PERFIL DESNÍVEL  
Adaptation profile | Profil d'adaptation

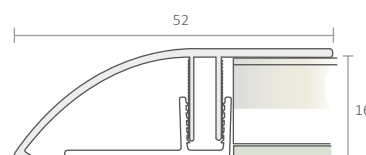

Ref: 43.0302.003

52mm

Para pavimentos até 16 mm  
For floorings until 16 mm  
Pour des sols jusqu'à 16 mm

AN PVC

10 Uni.

Comprimento | Length | Longueur: 2500 mm

**PERFIL TERMINAL**  
Edge profile | Profil d'arrêt

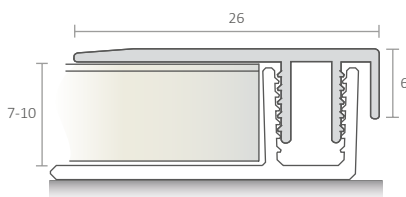

Ref: 43.0201.001

**26 mm**

Para pavimentos até 10 mm  
For floorings until 10mm  
Pour des sols jusqu'à 10 mm



10 Uni.

Comprimento | Length | Longueur: 2500 mm

Consultar disponibilidade para a gama SPC | Check availability for the SPC color range | Vérifiez la disponibilité de la gamme de couleurs SPC

**PERFIL RAMPA**  
Ramp profile | Profil de rampe

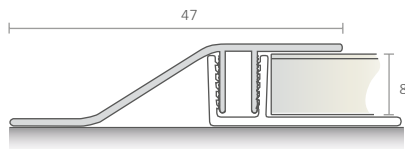

Ref: 43.0402.001

**47 mm**

Para pavimentos até 8 mm  
For floorings until 8 mm  
Pour des sols jusqu'à 8 mm



10 Uni.

Comprimento | Length | Longueur: 2500 mm

ESPECIFICAÇÕES | SPECIFICATIONS | SPÉCIFICATIONS

Liga Alumínio EN AW- 6030 / 6060 ( AL MG SI ) T5/6 EN 573-3 e EN 755-2  
Aluminum Alloy: EN AW- 6030 / 6060 ( AL MG SI ) T5/6 EN 573-3 e EN 755-2  
Alliage d'aluminium: EN AW- 6030 / 6060 ( AL MG SI ) T5/6 EN 573-3 e EN 755-2

Base necessária para a instalação  
Base required for installation  
Base nécessaire pour la pose

**SÉRIE PERFIL E BASE PVC | Profile Serie and PVC Base | Serie Profil et base en PVC**

**PERFIL DE TRANSIÇÃO**  
Transition profile | Profil de transition

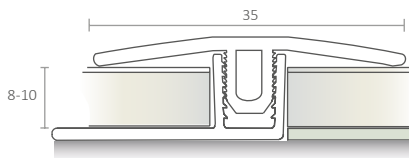

Ref: 43.0102.003

**35 mm**

Para pavimentos até 10 mm  
For floorings until 10 mm  
Pour des sols jusqu'à 10 mm



10 Uni.

Comprimento | Length | Longueur: 2500 mm

**BASE PVC**  
PVC Base | Base en PVC

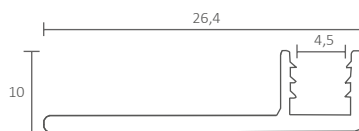

Ref: 43.0601.001

**7- 12 mm**

Para pavimentos até 12 mm  
For floorings until 12 mm  
Pour des sols jusqu'à 12 mm



10 Uni.

Comprimento | Length | Longueur: 2500 mm

**BASE PVC**  
PVC Base | Base en PVC

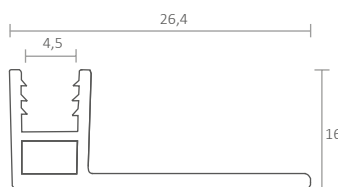

Ref: 43.0601.002

**14- 16 mm**

Para pavimentos até 16 mm  
For floorings until 16 mm  
Pour des sols jusqu'à 16 mm



10 Uni.

Comprimento | Length | Longueur: 2500 mm



Consultar os acabamentos disponíveis nas páginas 62 e 63.  
Consult the available finishes on pages 62 and 63.  
Consultez les finitions disponibles aux pages 62 et 63.



Alumínio anodizado  
Natural aluminium  
Aluminium naturel

Dimensões em milímetros  
Dimensions in millimeters  
Dimensions en millimètres

SÉRIE ALUMÍNIO TAPIT | Aluminium Tapit Serie | Serie Aluminium Tapit

PERFIL DE TRANSIÇÃO  
Transition profile | Profil de transition

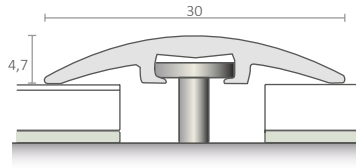

Ref: 43.0101.001

30mm

Fixação por parafuso tapit  
Nail anchor fixing  
Fixation par Cheville invisible

AN PVC

10 Uni.

Comprimento | Length | Longueur: 2500 mm

Produto a descontinuar | Product to be discontinued | Produit à arrêter

PERFIL DE TRANSIÇÃO  
Transition profile | Profil de transition

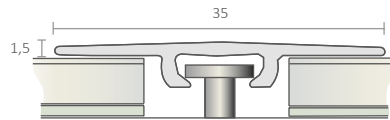

Ref: 43.0101.002

35mm

Fixação por parafuso tapit  
Nail anchor fixing  
Fixation par Cheville invisible

AN PVC

10 Uni.

Comprimento | Length | Longueur: 2500 mm

Produto a descontinuar | Product to be discontinued | Produit à arrêter

SÉRIE ALUMÍNIO TAPIT inclui 9 parafusos tapit de 6,45 mm.  
Aluminium Tapit Serie includes 9 6,45 mm nail anchors.  
Serie Aluminium Tapit inclus 9 chevilles invisibles de 6,45 mm.

ESPECIFICAÇÕES | SPECIFICATIONS | SPÉCIFICATIONS

Liga Alumínio EN AW- 6030 / 6060 ( AL MG SI ) T5/6 EN 573-3 e EN 755-2  
Aluminum Alloy: EN AW- 6030 / 6060 ( AL MG SI ) T5/6 EN 573-3 e EN 755-2  
Alliage d'aluminium: EN AW- 6030 / 6060 ( AL MG SI ) T5/6 EN 573-3 e EN 755-2

SÉRIE ALUMÍNIO BASE ALUMÍNIO | Aluminium serie with aluminium base | Serie Aluminium avec base en aluminium

PERFIL DE ESCADA  
Stair profile | Nez de marche

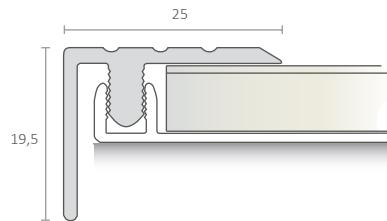

Ref: 43.0502.001

25 mm

Base necessária para a instalação  
Base required for installation  
Base nécessaire pour la pose

AN PVC

10 Uni.

Comprimento | Length | Longueur: 2500 mm

BASE DE FIXAÇÃO  
Fixation base | Base de fixation

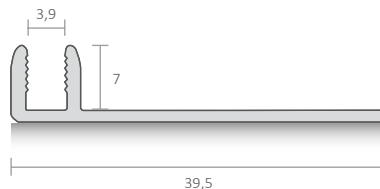

Ref: 43.0602.001

7- 12 mm

Para pavimentos de 7 a 12 mm  
For floorings from 7 to 12 mm  
Pour lames de 7 à 12 mm

AB

10 Uni.

Comprimento | Length | Longueur: 2500 mm

BASE DE FIXAÇÃO  
Fixation base | Base de fixation

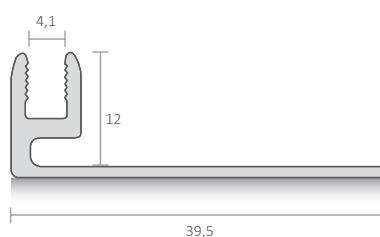

Ref: 43.0602.002

12- 15 mm

Para pavimentos de 12 a 15 mm  
For floorings from 12 to 15 mm  
Pour lames de 12 à 15 mm

AB

10 Uni.

Comprimento | Length | Longueur: 2500 mm

SÉRIE ALUMÍNIO TERMINAL | Aluminium End Profile Serie | Serie Aluminium Finition Profils

**PERFIL TERMINAL**  
Edge profile | Profil d'arrêt

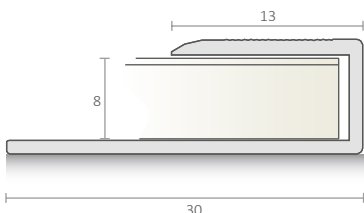

Ref: 43.0202.001

**8- 13 mm**

Para pavimentos até 8 mm  
For floorings until 8 mm  
Pour des sols jusqu'à 8 mm



10 Uni.

Comprimento | Length | Longueur: 2500 mm

**PERFIL TERMINAL**  
Edge profile | Profil d'arrêt

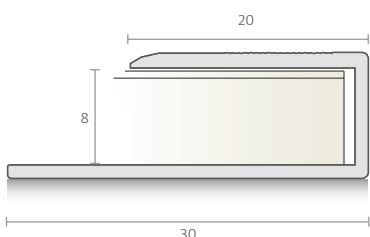

Ref: 43.0202.002

**8- 20 mm**

Para pavimentos até 8 mm  
For floorings until 8 mm  
Pour des sols jusqu'à 8 mm



10 Uni.

Comprimento | Length | Longueur: 2500 mm

**PERFIL TERMINAL**  
Edge profile | Profil d'arrêt

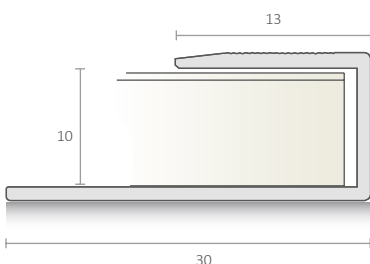

Ref: 43.0202.003

**10- 13 mm**

Para pavimentos até 10 mm  
For floorings until 10 mm  
Pour des sols jusqu'à 10 mm



10 Uni.

Comprimento | Length | Longueur: 2500 mm

**PERFIL TERMINAL**  
Edge profile | Profil d'arrêt

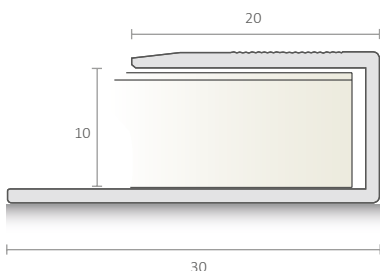

Ref: 43.0202.004

**10- 20 mm**

Para pavimentos até 10 mm  
For floorings until 10 mm  
Pour des sols jusqu'à 10 mm



10 Uni.

Comprimento | Length | Longueur: 2500 mm





ESPECIFICAÇÕES | SPECIFICATIONS | SPÉCIFICATIONS

Liga Alumínio EN AW- 6030 / 6060 (AL MG SI) T5/6 EN 573-3 e EN 755-2

Aluminum Alloy: EN AW- 6030 / 6060 (AL MG SI) T5/6 EN 573-3 e EN 755-2 | Alliage d'aluminium: EN AW- 6030 / 6060 (AL MG SI) T5/6 EN 573-3 e EN 755-2

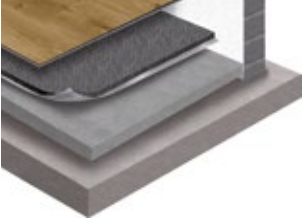

TELAS DE ISOLAMENTO | Underlay | Sous couches

TIPO DE TELA UNDERLAY TYPE TYPE DE SOUS COUCHES	CARATERÍSTICAS   CHARACTERISTICS   CARACTÉRISTIQUES							
	Rolo Roll (m²)	Espessura Thickness Epaisseur (mm)	Largura Width Largeur (m)	(Kg/m³)	(m² K/W)	(%)	(dB)	
Ref: 44.0202.001	LVT F LVT F   LVT F							
	10	1,5	1	950	0,0091	38,1	18	✓
Ref: 44.0201.008	EVA FLEX RADIANT Eva Flex Radiant   Eva Flex Radiant							
	30	2	1,2	150	0,022	22	22	✓
Ref: 44.0201.005   006	EVA FLEX Eva Flex   Eva Flex							
	15   30	2	1,2	125	0,044	22	26	✓
Ref: 44.0102.006   008	TOP PARQUET (Polietileno com plástico) Polyethylene with plastic   Polyéthylène avec plastique isolant							
	90   45	3	1,2	24	—	—	18	✓

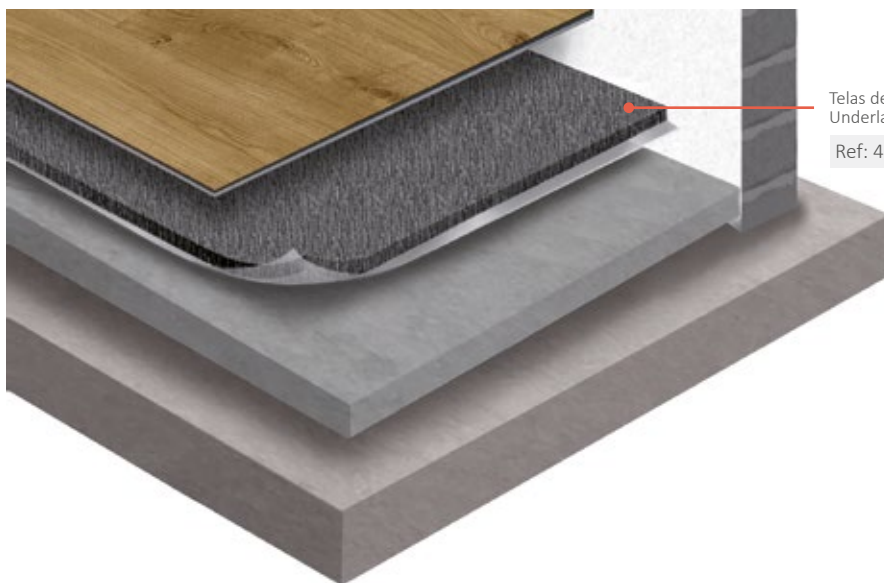

Telas de isolamento  
Underlay | Sous couches  
Ref: 44.0202.001



flooring solutions by gossimat

GS floors

Solid

ACS

GS floors

CORES DISPONÍVEIS  
AVAILABLE COLOURS | COULEURS DISPONIBLES



GAMA Gamma   Gamme	RODAPÉS Skirtings   Plinthes		PERFIS DE REMATE Aluminium Profiles   Profils en aluminium					
	WPC WPC	SPC SPC	Alumínio c/ base PVC Aluminium w/ PVC base Aluminium av/ base PVC	Perfil e base PVC Profile and PVC base Profil et base PVC	Tapit Nail anchor Cheville	Terminal End Profile Finition	Base alumínio Aluminium base Base aluminium	
	Pag.49	Pag.51	Pag.52	Pag.53	Pag.54	Pag.55	Pag.54	



	Lacado Branco White Lacquered   Laqué blanc	✓	—	—	—	—	—	—
	Alumínio anodizado Anodized alum.   Alum. anodisé	—	✓	✓	✓	✓	✓	✓

**PVC** PVC | PVC | PVC

	Carvalho Branco White Oak   Chêne Blanc	✓	—	✓	✓	✓	✓	✓
	Carvalho Reconst. Rebuilt Oak   Chêne Reconst.	✓	—	✓	✓	✓	✓	✓
	Cerejeira Cherry   Cerisier	✓	—	✓	✓	✓	✓	✓
	Faia Vaporizada Streamed beech   Hêtre étuvé	✓	—	✓	✓	✓	✓	✓
	Mogno Mahogany   Acajou	✓	—	✓	✓	✓	✓	✓
	Nogueira Walnut   Noyer	✓	✓	✓	✓	✓	✓	✓
	Sucupira Sucupira	✓	—	✓	✓	✓	✓	✓
	Teka Teak   Teck	✓	—	✓	✓	✓	✓	✓
	Wengue Wenge   Wenge	✓	—	✓	✓	✓	✓	✓

**VIN** VINIL | Vinyl | Vinyle

	Branco Artic Artic White   Blanc Artic	✓	—	—	—	—	—	—
	Branco Pérola Pearl White   Blanc Perla	✓	—	—	—	—	—	—
	Moldau Acacia Moldau Acacia	✓	—	—	—	—	—	—
	Carvalho Antiqua Antiqua Oak   Chêne Antiqua	✓	—	—	—	—	—	—
	Olmo Escuro Dark Elm   Orme Foncé	✓	—	—	—	—	—	—
	Carvalho Plomo Plomb Oak   Chêne Plomb	✓	—	—	—	—	—	—
	Carvalho Brown Brown Oak   Chêne Brun	✓	—	—	—	—	—	—
	Light Grey Light Grey	✓	—	—	—	—	—	—
	Dark Grey Dark Grey   Gris Foncé	✓	—	—	—	—	—	—
	Carvalho Savannah Savannah Oak   C. Savannah	✓	—	—	—	—	—	—
	Nogueira Cacao Cacao Walnut   Noyer Cacao	✓	—	—	—	—	—	—
	Concrete Concrete   Béton	✓	—	—	—	—	—	—
	Olmo Taupe Taupe Elm   Orme Taupe	✓	—	—	—	—	—	—
	Chestnut Bleached	✓	—	—	—	—	—	—
	Chestnut Marron	✓	—	—	—	—	—	—
	Olive	✓	—	—	—	—	—	—
	Nogueira Caramelo	✓	—	—	—	—	—	—
	Decor Branco White Decor   Decor Blanc	✓	—	—	—	—	—	—





A reprodução de cores é meramente ilustrativa podendo variar a sua tonalidade para a amostra física do produto.

(EN) The color reproduction is merely illustrative and its tone may vary from the real product. (FR) La reproduction des couleurs est simplement illustrative et son ton peut varier du le produit réel.



GAMA Gamma   Gamme DECOR-SPC   SPC Decor   Decor-SPC	RODAPÉS Skirtings   Plinthes		PERFIS DE REMATE Aluminium Profiles   Profils en aluminium				
	WPC WPC	SPC SPC	Alumínio c/ base PVC Aluminium w/ PVC base Aluminium av/ base PVC	Perfil e base PVC Profile and PVC base Profil et base PVC	Tapit Nail anchor Cheville	Terminal End Profile Finition	Base alumínio Aluminium base Base aluminium
	Pag.49	Pag.51	Pag.52	Pag.53	Pag.54	Pag.55	Pag.54

**SPC** SPC | SPC | SPC

**SOLID CLICK XL**

	Vanilla Oak	✓	✓	✓	—	—	—	—
	Pearl Oak	✓	✓	✓	—	—	—	—
	Iron Oak	✓	✓	✓	—	—	—	—
	Nature Oak	✓	✓	✓	—	—	—	—
	Honey Oak	✓	✓	✓	—	—	—	—
	Arizona Oak	✓	✓	✓	—	—	—	—
	Smoked Oak	✓	✓	✓	—	—	—	—
	Graphite Oak	✓	✓	✓	—	—	—	—
	Harvest Oak	✓	✓	✓	—	—	—	—
	Arabian Oak	✓	✓	✓	—	—	—	—
	Castle Oak	✓	✓	✓	—	—	—	—
	Ivory Oak	✓	✓	✓	—	—	—	—
	Riga Amber	✓	✓	✓	—	—	—	—
	Riga Terracota	✓	✓	✓	—	—	—	—
	Coyote Oak	✓	✓	✓	—	—	—	—
	Barley Oak	✓	✓	✓	—	—	—	—
	Havana Oak	✓	✓	✓	—	—	—	—
	Dakota Oak	✓	✓	✓	—	—	—	—
	Signature Oak	✓	✓	✓	—	—	—	—

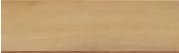

**ESSENCE | ACOUSTIC**

 *	Mystic Oak	—	—	—	—	—	—	—
	Forest Oak	✓	✓	✓	—	—	—	—
	Bohemian Walnut	✓	✓	✓	—	—	—	—

**ESSENCE**

	Royal Oak	✓	✓	✓	—	—	—	—
	Heritage Oak	✓	✓	✓	—	—	—	—
 *	Western Oak	—	—	—	—	—	—	—
	Urban Oak	✓	✓	✓	—	—	—	—

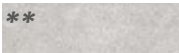
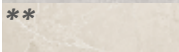
**STONE**

 **	Stonecrete	—	—	—	—	—	—	—
 **	Noble Marble	—	—	—	—	—	—	—
 **	Callacatta Praliné	—	—	—	—	—	—	—



Rua do Olival, 499- Marrazes 2415-527  
Leiria - PORTUGAL

t. +351 244 882 596 f. +351 244 881 318  
+351 244 849 210 m. +351 919 728 210  
GPS Lat. 39.762310º Long.-8.815820º  
geral@gosimat.pt www.gosimat.pt



GS FLOORS é uma marca registada da GOSIMAT  
GS FLOORS is a GOSIMAT trademark | GS FLOORS est une marque de GOSIMAT

A GOSIMAT reserva-se ao direito de fazer alteração sem aviso prévio dos conteúdos apresentados.  
The company reserves the right to make changes to any information contained in this document without prior notice.  
Nous nous réservons le droit de modifier la information contenue dans ce document à tout moment et sans préavis.

Todos os direitos reservados. A reprodução total ou parcial do conteúdo deste catálogo é proibida.  
All rights reserved. Any unauthorized reproduction of this content, in part or whole, is strictly prohibited. | Tous droits réservés. La reproduction totale ou partielle du contenu de ce catalogue est strictement interdite.

